

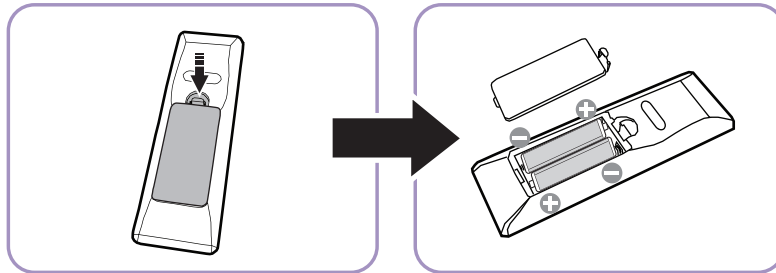

Remote control

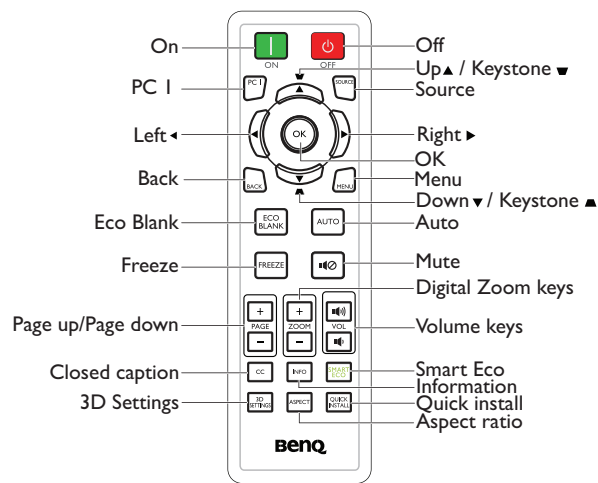

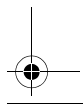

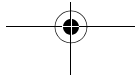
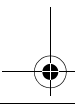
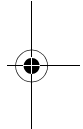
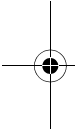
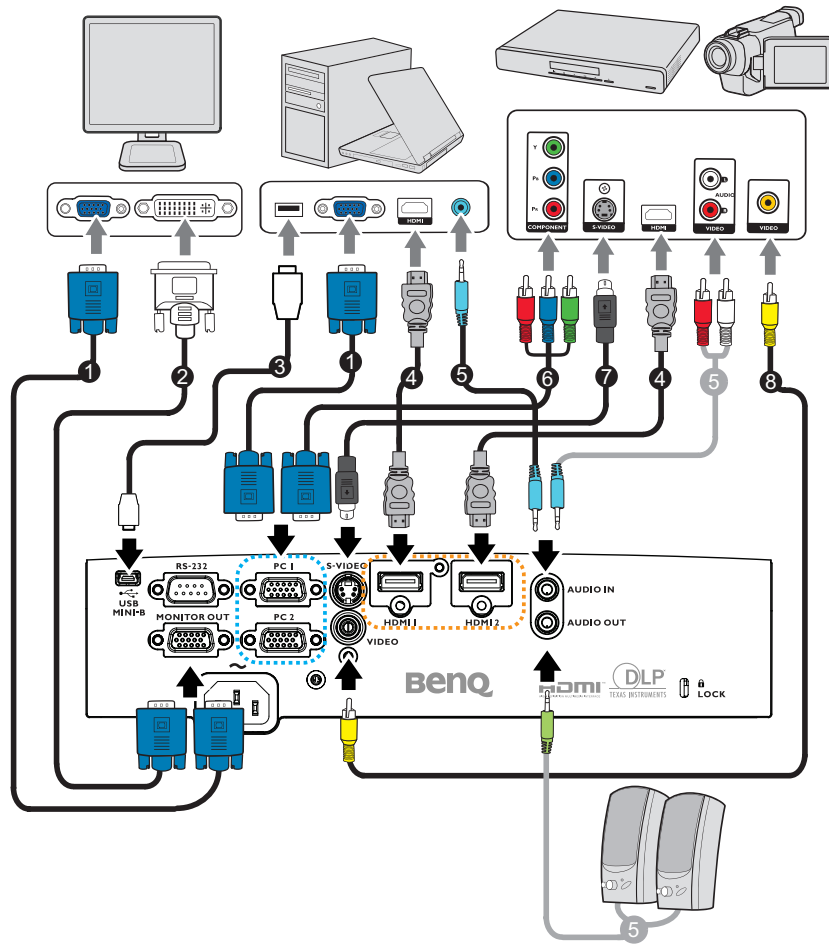

Projector dimensions

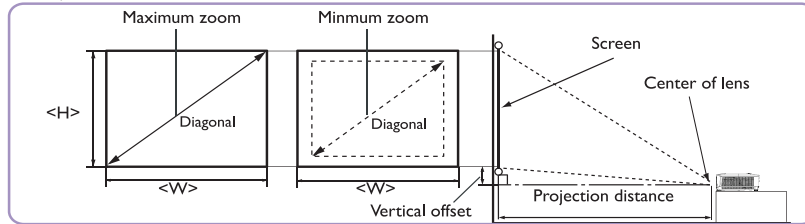

MS531/MX532/MS521H

Screen size				Distance from screen(mm)			Vertical offset (mm)
Diagonal		W (mm)	H (mm)	Min length (max. zoom)	Average	Max length (min. zoom)	
Inch	mm						
30	762	610	457	1183	1298	1414	27
35	889	711	533	1380	1515	1650	32
40	1016	813	610	1577	1731	1886	37
50	1270	1016	762	1971	2164	2357	46
60	1524	1219	914	2365	2597	2829	55
80	2032	1626	1219	3154	3463	3771	73
100	2540	2032	1524	3942	4328	4714	91
120	3048	2438	1829	4730	5194	5657	110
150	3810	3048	2286	5913	6492	7071	137
200	5080	4064	3048	7884	8656	9428	183
220	5588	4470	3353	8673	9522	10371	201
250	6350	5080	3810	9855	10820	11786	229
300	7620	6096	4572	11826	12984	14143	274

MW533/TW533

Screen size				Distance from screen(mm)			Vertical offset (mm)
Diagonal		W (mm)	H (mm)	Min length (max. zoom)	Average	Max length (min. zoom)	
Inch	mm						
30	762	646	404	1002	1102	1202	16
35	889	754	471	1168	1285	1402	19
40	1016	862	538	1335	1469	1603	22
50	1270	1077	673	1669	1836	2003	27
60	1524	1292	808	2003	2203	2404	32
80	2032	1723	1077	2671	2938	3205	43
100	2540	2154	1346	3339	3672	4006	54
120	3048	2585	1615	4006	4407	4808	65
150	3810	3231	2019	5008	5509	6009	81
200	5080	4308	2692	6677	7345	8013	108
220	5588	4739	2962	7345	8079	8814	118
250	6350	5385	3365	8346	9181	10016	135
300	7620	6462	4039	10016	11017	12019	162

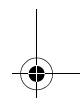
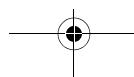
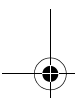
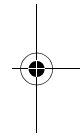
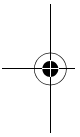

Projector dimensions

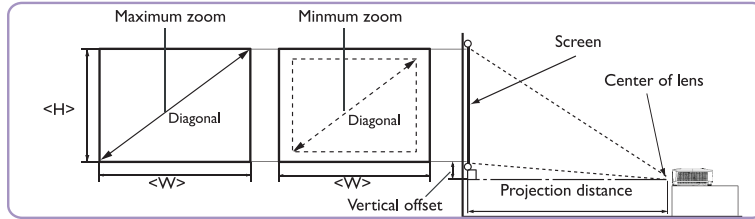

MH534/TH534

Screen size				Distance from screen(mm)			Vertical offset (mm)
Diagonal		W (mm)	H (mm)	Min length (max. zoom)	Average	Max length (min. zoom)	
Inch	mm						
30	762	664	374	850	943	1036	26
35	889	775	436	992	1100	1209	31
40	1016	886	498	1133	1257	1381	35
50	1270	1107	623	1417	1572	1727	44
60	1524	1328	747	1700	1886	2072	52
80	2032	1771	996	2267	2515	2763	70
100	2540	2214	1245	2834	3144	3454	87
120	3048	2657	1494	3400	3772	4144	105
150	3810	3321	1868	4250	4715	5180	131
200	5080	4428	2491	5667	6287	6907	174
220	5588	4870	2740	6234	6916	7598	192
250	6350	5535	3313	7084	7859	8634	218
300	7620	6641	3736	8501	9431	10361	262



The above numbers are approximate and may be slightly different from the actual measurements. Only the recommended screen sizes are listed. If your screen size is not in the table above, please contact your dealer for assistance.



Ceiling mount screw: M4
(Max L = 25 mm; Min L=20 mm) Unit: mm

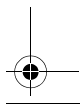
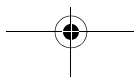
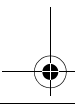
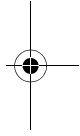
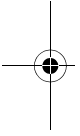
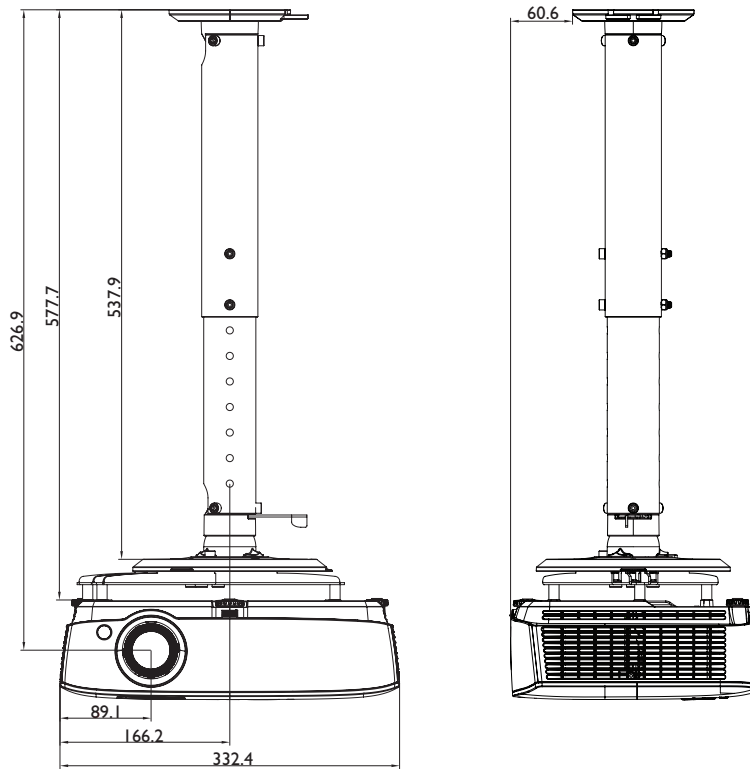
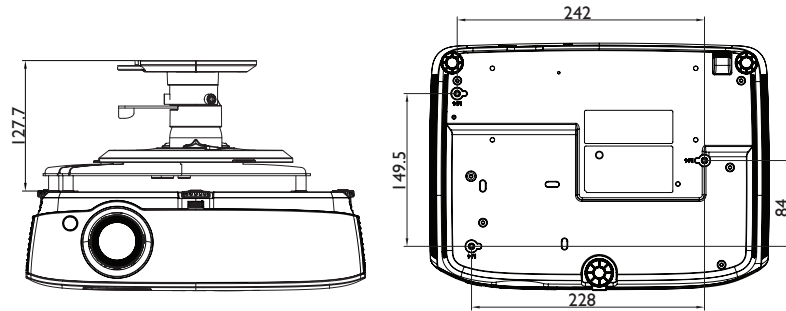

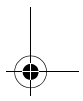
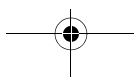
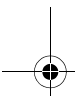
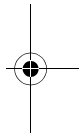
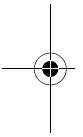
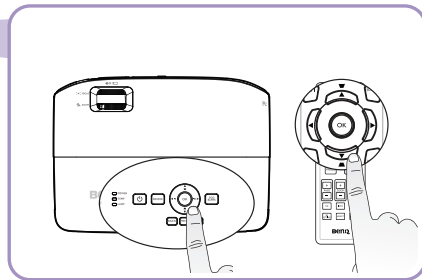
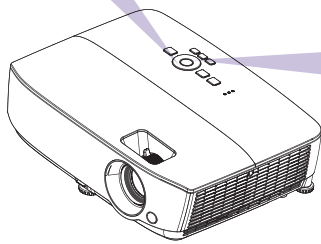
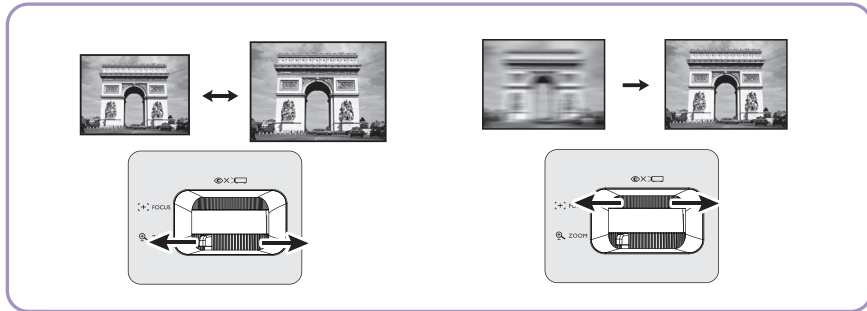

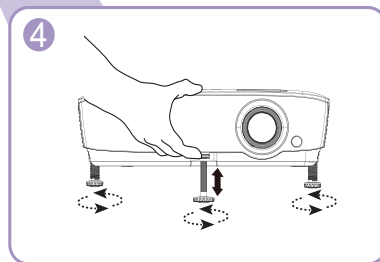
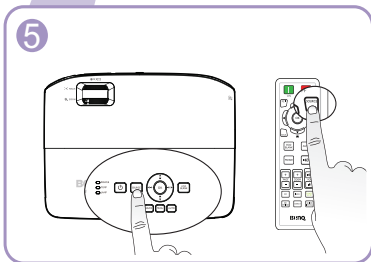
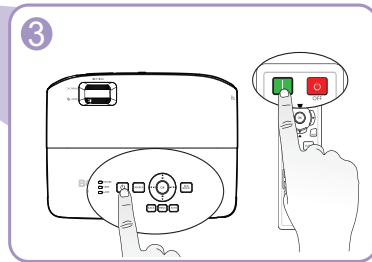
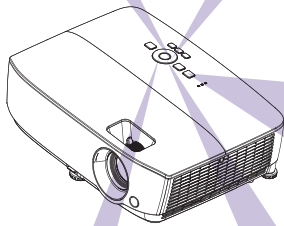
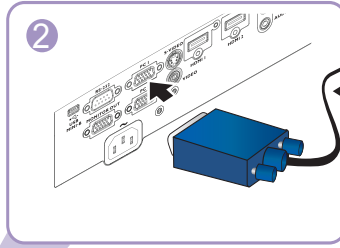
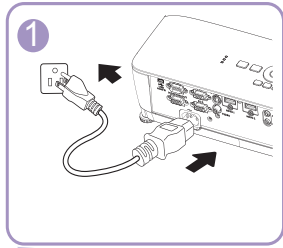

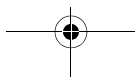
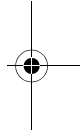
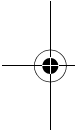
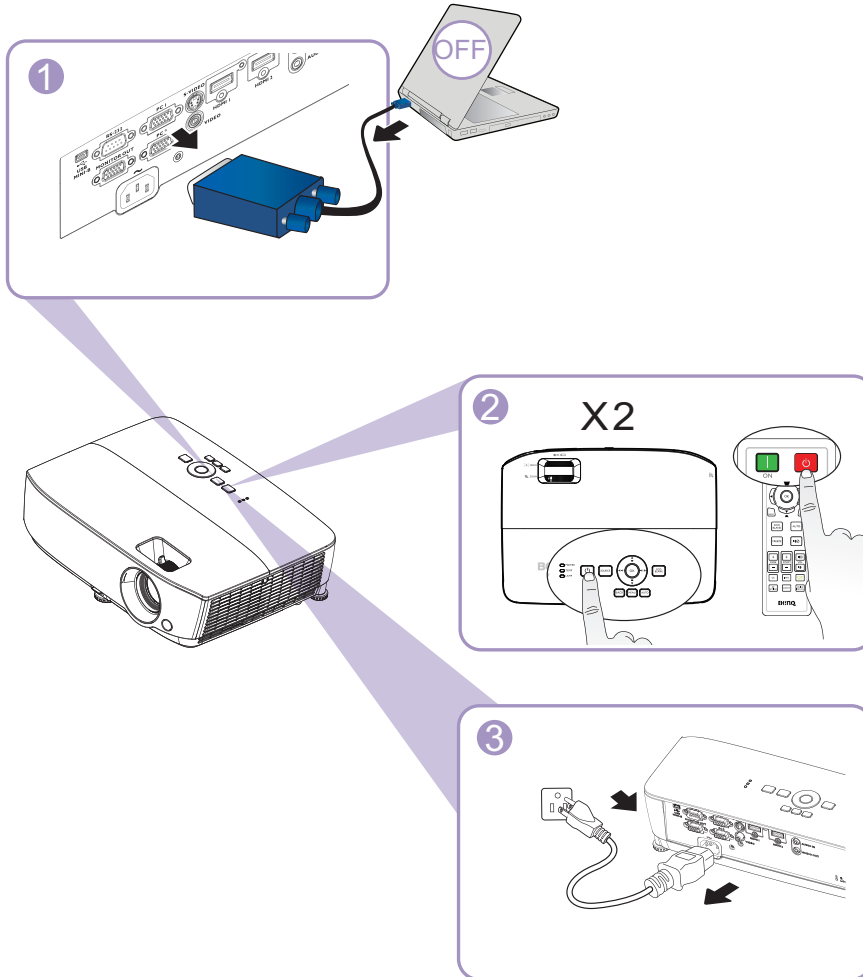
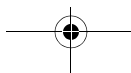
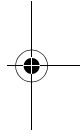
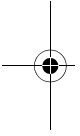



Table of contents

English	12
Français	13
Deutsch	14
Italiano	15
Español	16
Português	17
Svenska	18
Русский	19
Nederlands	20
Polski	21
Türkçe	22
Čeština	23
ไทย	24
繁體中文	25
简体中文	26
日本語	27
한국어	28
العربية	29



Specifications

(EN)

 All specifications are subject to change without notice.

Optical

Resolution

MS531/MS521H: 800 x 600 SVGA
 MX532: 1024 x 768 XGA
 MW533/TW533: 1280 x 800 WXGA
 MH534/TH534: 1920 x 1080 1080p

Display system

I-CHIP DMD

Lens F/Number

MS531/MX532/MW533/TW533/MS521H
 F = 2.46 to 2.66
 f = 21.8 to 25.6 mm
 MH534/TH534
 F = 2.42 to 2.62
 f = 19.0 to 22.65 mm

Offset

MS531/MX532/MS521H: 106±5%
 MW533/TW533: 104±5%
 MH534/TH534: 107±5%

Zoom ratio

1.2X
 Lamp
 203 W lamp

Electrical

Power supply

AC100-240V, 2.60 A,
 50-60 Hz (Automatic)

Power consumption

260 W (Max); < 0.5 W (Standby)

Mechanical

Weight

MS531/MX532/MS521H:
 2.38 kg (5.24 lbs)
 MW533/TW533: 2.41 kg (5.31 lbs)
 MH534/TH534: 2.42 kg (5.33 lbs)

Output terminals

RGB output

D-Sub 15-pin (female) x 1

Speaker

(Stereo) 2 watt x 1

Audio output

PC audio jack x 1

Control

RS-232 serial control

9 pin x 1

IR receiver x 1

USB mini-B x 1

Input terminals

Computer input

RGB input

D-Sub 15-pin (female) x 2

Video signal input

S-VIDEO

Mini DIN 4-pin port x 1

VIDEO

RCA jack x 1

SD/HDTV signal input

Analog - Component RCA jack x 3
 (through RGB input)

Digital-HDMI x 2

Audio signal input

Audio in

PC audio jack x 1

Environmental Requirements

Temperature

Operating: 0°C-40°C at sea level

Storage: -20°C-60°C at sea level

Relative humidity

Operating: 10%-90% (without condensation)

Storage: 10%-90% (without condensation)

Altitude

Operating: 0-1499 m at 0°C-35°C; 1500-3000
 m at 0°C-30°C (with High Altitude Mode on)

Storage: 0-12200 m at 30°C

Transporting

Original packing or equivalent is recommended.

Repairing

Please visit below website and choose your country to find your service contact window.
<http://www.benq.com/welcome>

 Lamp life results will vary depending on environmental conditions and usage.



(FR)

Caractéristiques

Toutes les caractéristiques peuvent être modifiées sans notification préalable.

Caractéristiques optiques

Résolution

MS531/MS521H : 800 x 600 SVGA
MX532 : 1024 x 768 XGA
MW533/TW533 : 1280 x 800 WXGA
MH534/TH534 : 1920 x 1080 1080p

Système d'affichage

I-CHIP DMD

Ouverture (nombre F)

MS531/MX532/MW533/TW533/MS521H
F = 2,46 à 2,66
f = 21,8 à 25,6 mm
MH534/TH534
F = 2,42 à 2,62
f = 19,0 à 22,65 mm

Décalage

MS531/MX532/MS521H : 106±5%
MW533/TW533 : 104±5%
MH534/TH534 : 107±5%

Zoom

1,2X
Lampe
Lampe 203 W

Caractéristiques électriques

Alimentation

100–240V CA, 2,60 A,
50–60 Hz (Automatique)

Consommation

260 W (Maxi) ; < 0,5 W (Veille)

Caractéristiques mécaniques

Poids

MS531/MX532/MS521H : 2,38 kg (5,24 livres)
MW533/TW533 : 2,41 kg (5,31 livres)
MH534/TH534 : 2,42 kg (5,33 livres)

Terminaux de sortie

Sortie RGB

D-Sub 15 broches (femelle) x 1

Haut-parleur

(Stéréo) 2 watts x 1

Sortie signal audio

Prise audio PC x 1

Contrôle

Contrôle série RS-232

9 broches x 1

Récepteur IR x 1

USB mini-B x 1

Terminaux d'entrée

Entrée ordinateur

Entrée RGB

D-Sub 15 broches (femelle) x 2

Entrée signal vidéo

S-VIDEO

Port mini DIN 4 broches x 1

VIDEO

Prise RCA x 1

Entrée de signal SD/HDTV

Prise RCA analogique - composantes x 3

(via entrée RGB)

Numérique-HDMI x 2

Entrée signal audio

Entrée audio

Prise audio PC x 1

Caractéristiques environnementales

Température

Fonctionnement : 0°C à 40°C au niveau de la mer

Stockage : -20°C à 60°C au niveau de la mer

Humidité relative

Fonctionnement : 10%-90% (sans condensation)

Stockage : 10%-90% (sans condensation)

Altitude

Fonctionnement : 0-1499 m à 0°C-35°C ;
1500-3000 m à 0°C-30°C (avec Mode Haute altitude activé)

Stockage : 0-12200 m à 30°C

Transport

L'emballage original ou équivalent est recommandé.

Réparation

Veuillez consulter le site Web ci-dessous et choisir votre pays pour trouver la fenêtre Contact de service.

<http://www.benq.com/welcome>

Les résultats en termes de durée de vie de la lampe dépendront des conditions environnementales et d'utilisation.

Technische Daten



 **Änderungen aller technischen Daten sind vorbehalten.**

Optische Daten

Auflösung
 MS531/MS521H: 800 x 600 SVGA
 MX532: 1024 x 768 XGA
 MW533/TW533: 1280 x 800 WXGA
 MH534/TH534: 1920 x 1080 1080p

Anzeigesystem
 I-CHIP DMD

F-Wert des Objektivs
 MS531/MX532/MW533/TW533/MS521H
 F = 2,46 bis 2,66
 f = 21,8 bis 25,6 mm
 MH534/TH534
 F = 2,42 bis 2,62
 f = 19,0 bis 22,65 mm

Versatz
 MS531/MX532/MS521H: 106±5%
 MW533/TW533: 104±5%
 MH534/TH534: 107±5%

Zoomverhältnis
 1,2-fach
 Lampe
 203-Watt-Lampe

Elektrische Daten

Stromversorgung
 100 bis 240 V~, 2,60 A
 50-60 Hz (automatisch)

Energieverbrauch
 260 W (maximal); < 0,5 W (Bereitschaft)

Mechanische Daten

Gewicht
 MS531/MX532/MS521H: 2,38 kg
 MW533/TW533: 2,41 kg
 MH534/TH534: 2,42 kg

Ausgänge

RGB-Ausgang
 D-Sub, 15-polig (weiblich) x 1

Lautsprecher
 (Stereo) 2 Watt x 1

Audioausgang
 PC-Audioanschluss x 1

Steuerung

Serielle RS-232-Steuerung
 9-polig x 1
 Infrarotempfänger x 1
 USB, Mini B x 1

Eingänge

Computereingang
 RGB-Eingang
 D-Sub, 15-polig (weiblich) x 2

Videosignaleingang
 S-VIDEO
 Mini-DIN, 4-polig x 1
 VIDEO
 Cinchanschluss x 1
 SD/HDTV-Signaleingang
 Analog - Component-Cinchanschluss x 3
 (über RGB-Eingang)
 Digital-HDMI x 2

Audioeingang
 Audioeingang
 PC-Audioanschluss x 1

Umgebungsbedingungen

Temperatur
 Betrieb: 0°C–40°C in Meeresspiegelhöhe
 Lagerung: -20°C–60°C in Meeresspiegelhöhe

Relative Feuchtigkeit
 Betrieb: 10%-90% (nicht kondensierend)
 Lagerung: 10%-90% (nicht kondensierend)

Höhe
 Betrieb: 0 bis 1499 m bei 0 bis 35°C; 1500 bis 3000 m bei 0 bis 30°C (bei eingeschaltetem Höhenmodus)
 Lagerung: 0 bis 12200 m bei 30°C

Transport
 Originalverpackung oder gleichwertige Verpackung wird empfohlen.

Reparatur
 Bitte besuchen Sie die nachstehende Webseite und wählen Sie Ihr Land. Dadurch erscheint Ihr Servicekontaktfenster.
<http://www.benq.com/welcome>

 **Die Betriebszeit der Lampe hängt von Umgebungs- und Nutzungsbedingungen ab.**



Specifiche tecniche

Tutte le specifiche sono soggette a modifiche senza preavviso.

Ottica

Risoluzione

MS531/MS521H: 800 x 600 SVGA
MX532: 1024 x 768 XGA
MW533/TW533: 1280 x 800 WXGA
MH534/TH534: 1920 x 1080 1080p

Sistema di visualizzazione

1-CHIP DMD

Numero/F dell'obiettivo

MS531/MX532/MW533/TW533/MS521H
F = da 2,41 a 2,66
f = da 21,8 a 25,6 mm
MH534/TH534
F = da 2,42 a 2,62
f = da 19,0 a 22,65 mm

Compensazione

MS531/MX532/MS521H: 106±5%
MW533/TW533: 104±5%
MH534/TH534: 107±5%

Portata dello zoom

1,2X
Lampada
Lampada 203 W

Elettricità

Alimentazione

CA 100-240V, 2,60 A,
50-60 Hz (Automatica)

Consumo energetico

260 W (massimo); < 0,5 W (Standby)

Meccanica

Peso

MS531/MX532/MS521H: 2,38 kg (5,24 lbs.)
MW533/TW533: 2,41 kg (5,31 lbs.)
MH534/TH534: 2,42 kg (5,33 lbs.)

Terminali d'uscita

Uscita RGB

D-Sub 15-pin (femmina) x 1

Altoparlante

(Stereo) 2 Watt x 1

Uscita segnale audio

Connettore audio PC x 1

Controllo

Controllo seriale RS-232

9 pin x 1

Ricevitore IR x 1

USB mini-B x 1

Terminali d'ingresso

Ingresso computer

Ingresso RGB

D-Sub 15-pin (femmina) x 2

Segnale ingresso video

S-VIDEO

Porta Mini DIN 4-pin x 1

VIDEO

Connettore RCA x 1

Ingresso segnale SD/HDTV

Connettore analogico - RCA a

componenti x 3

(tramite ingresso RGB)

Digitale - HDMI x 2

Ingresso segnale audio

Ingresso audio

Connettore audio PC x 1

Requisiti ambientali

Temperatura

Operativa: 0°C-40°C sul livello del mare

Conservazione: -20°C-60°C sul livello del mare

Umidità relativa

Operativa: 10%-90% (senza condensa)

Conservazione: 10%-90% (senza condensa)

Altitudine

Operativa: 0-1499 m a 0°C-35°C; 1500-3000 m a 0°C-30°C (con modalità Altitudine elevata attiva)

Conservazione: 0-12200 m a 30°C

Trasporto

Si consiglia la confezione originale o equivalente.

Riparazione

Visitare il sito web di seguito e selezionare il Paese per trovare la finestra di contatto assistenza.

<http://www.benq.com/welcome>

La durata della lampada varierà in base alle condizioni ambientali e d'uso.

Especificaciones

(ES)

 **Todas las especificaciones están sujetas a cambio sin previo aviso.**

Ópticas

Resolución

MS531/MS521H: 800 x 600 SVGA
 MX532: 1024 x 768 XGA
 MW533/TW533: 1280 x 800 WXGA
 MH534/TH534: 1920 x 1080 1080p

Sistema óptico

1 CHIP DMD

Lente F/Número

MS531/MX532/MW533/TW533/MS521H
 F = 2,46 a 2,66
 f = 21,8 a 25,6 mm
 MH534/TH534
 F = 2,42 a 2,62
 f = 19,0 a 22,65 mm

Desviación

MS531/MX532/MS521H: 106±5 %
 MW533/TW533: 104±5 %
 MH534/TH534: 107±5 %

Relación de zoom

1,2X
 Lámpara
 Lámpara de 203 W

Eléctricas

Fuente de alimentación

100-240 VCA, 2,60 A,
 50-60 Hz (automático)

Consumo de energía

260 W (máx); < 0,5 W (espera)

Mecánicas

Peso

MS531/MX532/MS521H: 2,38 kg (5,24 libras)
 MW533/TW533: 2,41 kg (5,31 libras)
 MH534/TH534: 2,42 kg (5,33 libras)

Terminales de salida

Salida RGB

D-Sub de 15 clavijas (hembra) x 1

Altavoz

(Estéreo) 2 vatios x 1

Salida de señal de audio

Conector de audio de PC x 1

Control

Control de serie RS-232

9 clavijas x 1

Receptor de infrarrojos x 1

USB mini-B x 1

Terminales de entrada

Entrada de ordenador

Entrada RGB

D-Sub de 15 clavijas (hembra) x 2

Entrada de señal de vídeo

S-VIDEO

Puerto Mini-DIN de 4 clavijas x 1

VIDEO

Conector RCA x 1

Entrada de señal de TV de definición estándar/
 alta definición

Analógica - Conector RCA de vídeo de
 componentes x 3

(a través de la entrada RGB)

HDMI digital x 2

Entrada de señal de audio

Entrada de audio

Conector de audio de PC x 1

Requisitos medioambientales

Temperatura

Funcionamiento: 0 °C-40 °C a nivel del mar

Almacenamiento: -20 °C-60 °C a nivel del mar

Humedad relativa

Funcionamiento: 10%-90% (sin condensación)

Almacenamiento: 10%-90% (sin condensación)

Altitud

Funcionamiento: 0-1499 m a 0 °C-35 °C;

1500-3000 m a 0 °C-30 °C (con la opción

Modo altitud elevada activada)

Almacenamiento: 0-12200 m a 30 °C

Transporte

Se recomienda el embalaje original o
 equivalente.

Reparación

Visite el siguiente sitio web y seleccione el país
 para encontrar su contacto de servicio
 técnico.

<http://www.benq.com/welcome>

 **La vida de la lámpara puede variar en función de las condiciones medioambientales y el uso.**



(PT)

Especificações

Todas as especificações estão sujeitas a alteração sem aviso prévio.

Ópticas

Resolução

MS531/MS521H: 800 x 600 SVGA
MX532: 1024 x 768 XGA
MW533/TW533: 1280 x 800 WXGA
MH534/TH534: 1920 x 1080 1080p

Sistema de visualização

I-CHIP DMD

Lente F/Número

MS531/MX532/MW533/TW533/MS521H
F = 2,46 a 2,66
f = 21,8 a 25,6 mm
MH534/TH534
F = 2,42 a 2,62
f = 19,0 a 22,65 mm

Desvio

MS531/MX532/MS521H: 106±5%
MW533/TW533: 104±5%
MH534/TH534: 107±5%

Taxa de zoom

1,2X
Lâmpada
Lâmpada de 203 W

Eléctricas

Fonte de alimentação

AC100-240V, 2,60 A,
50-60 Hz (Automático)

Consumo de energia

260 W (Máx); < 0,5 W (Modo de Espera)

Mecânicas

Peso

MS531/MX532/MS521H: 2,38 kg
MW533/TW533: 2,41 kg
MH534/TH534: 2,42 kg

Terminais de saída

Saída RGB

D-Sub de 15 pinos (fêmea) x 1

Altifalante

(Estéreo) 2 watts x 1

Saída do sinal de áudio

Tomada de áudio de PC x 1

Controlo

Controlo de série RS-232

9 pinos x 1

Receptor de IV x 1

USB mini-B x 1

Terminais de entrada

Entrada de computador

Entrada RGB

D-Sub de 15 pinos (fêmea) x 2

Entrada do sinal de vídeo

S-VIDEO

Porta mini DIN de 4 pinos x 1

VIDEO

Tomada RCA x 1

Entrada de sinal de TV SD/HD

Tomada RCA Analógico - Componente x 3

(através de entrada RGB)

Digital-HDMI x 2

Entrada de sinal de áudio

Entrada de áudio

Tomada de áudio de PC x 1

Requisitos ambientais

Temperatura

Funcionamento: 0°C-40°C ao nível do mar
Armazenamento: -20°C-60°C ao nível do mar

Humidade relativa

Funcionamento: 10%-90% (sem condensação)
Armazenamento: 10%-90% (sem condensação)

Altitude

Funcionamento: 0-1499 m a 0-35°C; 1500-3000 m a 0-30°C (com Modo Grande Altitude ligado)
Armazenamento: 0-12200 m a 30°C

Transporte

Recomenda-se a utilização da embalagem original ou equivalente.

Reparação

Visite o website indicado abaixo e escolha o seu país para encontrar as informações de contacto de assistência técnica.
<http://www.benq.com/welcome>

O tempo de vida útil da lâmpada poderá variar de acordo com as condições ambientais e modo de utilização.

Specifikationer

(S)

☞ **Alla specifikationer kan ändras utan föregående meddelande.**

Optik

Upplösning

MS531/MS521H: 800 x 600 SVGA
 MX532: 1024 x 768 XGA
 MW533/TW533: 1280 x 800 WXGA
 MH534/TH534: 1920 x 1080 1080p

Visningssystem

I-CHIP DMD

Linsens f-nummer

MS531/MX532/MW533/TW533/MS521H
 F = 2,46 till 2,66
 f = 21,8 till 25,6 mm
 MH534/TH534
 F = 2,42 till 2,62
 f = 19,0 till 22,65 mm

Förskjutning

MS531/MX532/MS521H: 106±5%
 MW533/TW533: 104±5%
 MH534/TH534: 107±5%

Zoomförhållande

1,2X
 Lampa
 203 W-lampa

EI

Strömförsörjning

100-240V växelström, 2,60 A,
 50-60 Hz (Automatiskt)

Strömförbrukning

260 W (Max); < 0,5 W (Standby)

Mekanik

Vikt

MS531/MX532/MS521H: 2,38 kg (5,24 lbs.)
 MW533/TW533: 2,41 kg (5,31 lbs.)
 MH534/TH534: 2,42 kg (5,33 lbs.)

Utgångsterminaler

RGB-utgång

D-Sub 15 stift (hona) x 1

Högtalare

(Stereo) 2 watt x 1

Ljudutgång

PC-ljudkontakt x 1

Kontroll

RS-232-seriekontroll

9 stift x 1

IR-mottagare x 1

USB mini B x 1

Ingångsterminaler

Datoringång

RGB-ingång

D-Sub 15 stift (hona) x 2

Videosignalingång

S-VIDEO

Mini DIN 4-stiftsport x 1

VIDEO

RCA-kontakt x 1

SD/HDTV-signalingång

Analog - Komponent RCA-kontakt x 3

(via RGB-ingång)

Digital-HDMI x 2

Ljudingång

Ljud in

PC-ljudkontakt x 1

Miljökrav

Temperatur

Drift: 0 °C-40 °C på havsnivå

Lagring: -20 °C-60 °C på havsnivå

Relativ luftfuktighet

Drift: 10-90 % (utan kondensation)

Lagring: 10-90 % (utan kondensation)

Höjd

Drift: 0-1499 m vid 0 °C-35 °C; 1500-3000 m

vid 0 °C-30 °C (med påslaget Höghöjdsäge)

Lagring: 0-12200 m vid 30 °C

Transport

Originalförpackning eller motsvarande rekommenderas.

Reparation

Besök webbplatsen nedan och välj ditt land för att hitta ditt servicekontaktfönster.

<http://www.benq.com/welcome>

☞ **Lampslängden varierar beroende på omgivningsförhållanden och användning.**



(RU)

Технические характеристики

Все характеристики могут изменяться без предварительного уведомления.

Оптические характеристики

Разрешение

MS531/MS521H: 800 x 600 SVGA
MX532: 1024 x 768 XGA
MW533/TW533: 1280 x 800 WXGA
MH534/TH534: 1920 x 1080 1080p

Проекционная система

Однокристальное цифровое
микрзеркальное устройство (DMD)

Объектив, фокусное расстояние

MS531/MX532/MW533/TW533/MS521H
F = 2,46 - 2,66
f = 21,8 - 25,6 мм
MH534/TH534
F = 2,42 - 2,62
f = 19,0 - 22,65 мм

Смещение

MS531/MX532/MS521H: 106±5%
MW533/TW533: 104±5%
MH534/TH534: 107±5%

Коэффициент масштабирования:

1,2X
Лампа
Лампа 203 Вт

Электрические характеристики

Питание

100–240 В переменного тока; 2,60 А;
50–60 Гц (авто)

Энергопотребление

260 Вт (макс.); < 0,5 Вт (режим ожидания)

Механические характеристики

Вес

MS531/MX532/MS521H: 2,38 кг (5,24
фунта)
MW533/TW533: 2,41 кг (5,31 фунта)
MH534/TH534: 2,42 кг (5,33 фунта)

Выходные разъемы

Выход RGB

D-Sub (15-контактов, гнездо) – 1 шт.

Динамик

(стерео), 2 Вт – 1 шт.

Выход аудиосигналов

Аудиоразъем ПК – 1 шт.

Управление

Управление через последовательный порт
RS-232

9 контактов – 1 шт.

ИК-приемник – 1 шт.

Мини-разъем USB типа B – 1 шт.

Входные разъемы

Вход компьютера

Вход RGB

D-Sub (15-контактов, гнездо) – 2 шт.

Вход видеосигнала

S-VIDEO

Порт Mini DIN (4-контакта) – 1 шт.

ВИДЕО

Гнездо RCA – 1 шт.

Вход сигнала SD/HDTV

Гнездо RCA аналогового компонентного

видеосигнала – 3 шт.

(через вход RGB)

Цифровой порт HDMI – 2 шт.

Вход аудиосигналов

Аудио вход

Аудиоразъем ПК – 1 шт.

Требования к окружающей среде

Температура

Рабочая: 0°C–40°C на уровне моря

Хранение: -20°C–60°C на уровне моря

Относительная влажность

Рабочая: от 10% до 90% (без
конденсации)

Хранение: от 10% до 90% (без
конденсации)

Высота

Рабочая: от 0 до 1 499 м при
температуре от 0 до 35°C; от 1500 до
3000 м при температуре от 0 до 30°C
(при включении режима большой
высоты)

Хранение: от 0 до 12200 м при
температуре 30°C

Транспортировка

Рекомендуется использовать
оригинальную или аналогичную
упаковку.

Ремонт

Чтобы найти окно связи с сервисным
центром, зайдите на приведенный ниже
веб-сайт и выберите свою страну.
<http://www.benq.com/welcome>

Срок службы лампы может быть различным в зависимости от внешних условий и режимов эксплуатации.

Specificaties

Alle specificaties kunnen zonder voorafgaande kennisgeving worden gewijzigd.

Optische specificaties

Resolutie

MS531/MS521H: 800 x 600 SVGA
 MX532: 1024 x 768 XGA
 MW533/TW533: 1280 x 800 WXGA
 MH534/TH534: 1920 x 1080 1080p

Weergavesysteem

I-CHIP DMD

Lens F/waarde

MS531/MX532/MW533/TW533/MS521H
 F = 2,46 tot 2,66
 f = 21,8 tot 25,6 mm
 MH534/TH534
 F = 2,42 tot 2,62
 f = 19,0 tot 22,65 mm

Offset

MS531/MX532/MS521H: 106±5%
 MW533/TW533: 104±5%
 MH534/TH534: 107±5%

Zoomfactor

1,2X
 Lamp
 Lamp van 203 W

Elektrische specificaties

Stroomtoevoer

AC100-240V, 2,60 A,
 50-60 Hz (automatisch)

Stroomverbruik

260 W (max); < 0,5 W (stand-by)

Mechanische specificaties

Gewicht

MS531/MX532/MS521H: 2,38 kg
 MW533/TW533: 2,41 kg
 MH534/TH534: 2,42 kg

Uitgangen

RGB-uitgang

D-Sub 15-pins (vrouwelijk) x 1

Luidspreker

(Stereo) 2 watt x 1

Audiosignaaluitgang

Pc-audio-aansluiting x 1

Besturing

Seriële besturing via RS-232

9-pins x 1

IR-ontvanger x 1

Mini USB B x 1

Ingangen

Computeringang

RGB-ingang

D-Sub 15-pins (vrouwelijk) x 2

Videosignaaluitgang

S-VIDEO

Mini DIN 4-pins poort x 1

VIDEO

RCA-stekker x 1

SD/HDTV-signaaluitgang

Analoge - Component RCA-aansluiting x 3

(via RGB-ingang)

Digitaal-HDMI x 2

Audiosignaaluitgang

Audio-ingang

Pc-audio-aansluiting x 1

Omgevingsvereisten

Temperatuur

Werkomgeving: 0°C-40°C op zeeniveau

Opslag: -20°C-60°C op zeeniveau

Relatieve vochtigheid

Werkomgeving: 10%-90% (zonder condensatie)

Opslag: 10%-90% (zonder condensatie)

Hoogte

Werkomgeving: 0-1499 m bij 0°C-35°C; 1500-3000 m bij 0°C-30°C (met Hoogtemodus ingeschakeld)

Opslag: 0-12200 m bij 30°C

Vervoeren

Originele verpakking of gelijksoortig wordt aanbevolen.

Bezig met repareren.

Bezoek onze website en kies uw land om het venster voor uw service contact te openen.

<http://www.benq.com/welcome>

De levensduur van de lamp zal verschillen, afhankelijk van de omgevingsomstandigheden en het gebruik.



(PL)

Specyfikacje

Wszystkie parametry techniczne mogą ulec zmianie bez wcześniejszego powiadomienia.

Parametry optyczne

Rozdzielczość

MS531/MS521H: 800 x 600 SVGA

MX532: 1024 x 768 XGA

MW533/TW533: 1280 x 800 WXGA

MH534/TH534: 1920 x 1080 1080p

Układ wyświetlania

1-CHIP DMD

Przysłona obiektywu

MS531/MX532/MW533/TW533/MS521H

F = 2,46 do 2,66

f = od 21,8 do 25,6 mm

MH534/TH534

F = 2,42 do 2,62

f = od 19,0 do 22,65 mm

Przesunięcie

MS531/MX532/MS521H: 106±5%

MW533/TW533: 104±5%

MH534/TH534: 107±5%

Współczynnik powiększenia

1,2X

Lampa

Lampa 203 W

Parametry elektryczne

Zasilanie

Prąd zmienny 100 - 240V, 2,60 A,

50-60 Hz (automatyczna)

Pobór mocy

260 W (maks.); < 0,5 W (tryb gotowości)

Parametry mechaniczne

Ciężar

MS531/MX532/MS521H: 2,38 kg (5,24 funta)

MW533/TW533: 2,41 kg (5,31 funta)

MH534/TH534: 2,42 kg (5,33 funta)

Złącza wyjścia

Wyjście RGB

15-pinowe D-Sub (żeńskie) x 1

Głośnik

(Stereo) 2 W x 1

Wyjście sygnału audio

Gniazdo audio PC x 1

Sterowanie

Port szeregowy RS-232

9 pinowe x 1

Odbiornik podczerwieni x 1

USB mini B x 1

Złącza wejścia

Wejście komputerowe

Wejście RGB

15-pinowe D-Sub (żeńskie) x 2

Wejście sygnału wideo

S-VIDEO

4-pinowe złącze Mini DIN x 1

VIDEO

Gniazdo RCA x 1

Wejście sygnału SD/HDTV

Analogowe - gniazdo Component

RCA x 3

(przez wejście RGB)

Cyfrowe - HDMI x 2

Wejście sygnału audio

Wejście audio

Gniazdo audio PC x 1

Wymagania środowiskowe

Temperatura

Praca: 0°C - 40°C na poziomie morza

Przechowywanie: -20°C - 60°C na poziomie morza

Wilgotność względna

Praca: 10%-90% (bez kondensacji)

Przechowywanie: 10%-90% (bez kondensacji)

Wysokość

Praca: 0–1499 m przy temperaturze 0°C–

35°C; 1500–3000 m przy temperaturze

0°C–30°C (z włączonym trybem dużej wysokości)

Przechowywanie: 0–12200 m przy temperaturze 30°C

Transport

Zalecane jest oryginalne opakowanie lub jego odpowiednik

Naprawy

Na poniższej witrynie internetowej wybierz kraj w celu znalezienia najbliższego punktu serwisowego.

<http://www.benq.com/welcome>

Żywotność lampy uzależniona jest od warunków środowiska pracy oraz intensywności użytkowania.

Teknik Özellikler

(TR)

 Tüm spesifikasyonlar, haber verilmeden değiştirilebilir.

Optik

Çözünürlük
MS531/MS521H: 800 x 600 SVGA
MX532: 1024 x 768 XGA
MW533/TW533: 1280 x 800 WXGA
MH534/TH534: 1920 x 1080 1080p

Görüntü sistemi
1-CHIP DMD

Lens F/Numarası
MS531/MX532/MW533/TW533/MS521H
F = 2,46 - 2,66
f = 21,8 - 25,6 mm
MH534/TH534
F = 2,42 - 2,62
f = 19,0 - 22,65 mm

Sapma

MS531/MX532/MS521H: 106±5%
MW533/TW533: 104±5%
MH534/TH534: 107±5%

Yakınlaştırma oranı

1,2X
Lamba
203 W lamba

Elektrik

Güç kaynağı
AC100-240V, 2,60 A,
50-60 Hz (Otomatik)

Güç tüketimi
260 W (Maks.); < 0,5 W (Bekleme)

Mekanik

Ağırlık
MS531/MX532/MS521H: 2,38 kg (5,24 lbs.)
MW533/TW533: 2,41 kg (5,31 lbs.)
MH534/TH534: 2,42 kg (5,33 lbs.)

Çıkış terminalleri

RGB çıkışı
D-Sub 15-pimli (dişi) x 1

Hoparlör
(Stereo) 2 vat x 1

Ses sinyali çıkışı
Bilgisayar sesi jakı x 1

Denetim

RS-232 seri kumanda
9 pim x 1
IR alıcısı x 1
USB mini B x 1

Giriş terminalleri

Bilgisayar girişi
RGB girişi
D-Sub 15-pimli (dişi) x 2

Video sinyali girişi
S-VIDEO
Mini DIN 4-pimli bağlantı noktası x 1

VIDEO
RCA jak x 1

SD/HDTV sinyal girişi
Analog - Komponent RCA jak x 3
(RGB girişinden)
Dijital-HDMI x 2

Ses sinyali girişi
Ses girişi
Bilgisayar sesi jakı x 1

Çevresel Gereklilikler

Sıcaklık
Çalışma: Deniz seviyesinde 0°C-40°C
Depolama: Deniz seviyesinde -20°C-60°C

Bağıl nem
Çalışma: %10-%90 (yoğuşmasız)
Depolama: %10-%90 (yoğuşmasız)

Yükseklik
Çalışma: 0°C-35°C'de 0-1499 m; 0°C-30°C'de 1500-3000 m (Yüksek Yer Modu açık olarak)
Depolama: 30°C'de 0-12200 m

Nakliye
Orijinal ambalaj veya eş değeri önerilir.

Onarım
Lütfen aşağıdaki web sitesini ziyaret edip, servis iletişimi bilgilerini bulmak için ülkenizi seçin.
<http://www.benq.com/welcome>

 Lamba ömrü sonuçları çevresel koşullara ve kullanıma bağlı olarak değişebilir.



(CS)

Technické údaje

Veškeré technické údaje se mohou změnit bez předchozího upozornění.

Optické parametry

Rozlišení

MS531/MS521H: 800 x 600 SVGA
MX532: 1024 x 768 XGA
MW533/TW533: 1280 x 800 WXGA
MH534/TH534: 1920 x 1080 1080p

Systém zobrazování

Jednočipový DMD

Clonové číslo objektivu

MS531/MX532/MW533/TW533/MS521H
F = 2,46 až 2,66
f = 21,8 až 25,6 mm
MH534/TH534
F = 2,42 až 2,62
f = 19,0 až 22,65 mm

Posun

MS531/MX532/MS521H: 106±5%
MW533/TW533: 104±5%
MH534/TH534: 107±5%

Poměr zvětšení

1,2X
Lampa
Lampa 203 W

Elektrické parametry

Napájení

100–240 V, 2,60 A,
50–60 Hz (automaticky)

Příkon

260 W (max); < 0,5 W (pohotovostní stav)

Mechanické parametry

Hmotnost

MS531/MX532/MS521H: 2,38 kg (5,24 lbs)
MW533/TW533: 2,41 kg (5,31 lbs)
MH534/TH534: 2,42 kg (5,33 lbs)

Výstupní terminály

RGB výstup

D-Sub 15 hrotů (samice) x 1

Reproduktor

(Stereo) 2 W x 1

Výstup zvukového signálu

PC audio konektor x 1

Ovládání

Konektor RS-232 (sériové dálkové ovládání)

9 hrotů x 1

Infračervený přijímač x 1

USB mini-B x 1

Vstupní terminály

Vstup signálu z počítače

Vstup RGB

D-Sub 15 hrotů (samice) x 2

Vstup video signálu

S-VIDEO

Mini DIN 4-hrotový port x 1

VIDEO

RCA konektor x 1

Vstup signálu SD/HDTV

Analogový - komponentní RCA
konektor x 3

(přes vstup RGB)

Digitální-HDMI x 2

Vstup zvukového signálu

Vstup zvuku

PC audio konektor x 1

Požadavky z hlediska životního prostředí

Teplota

Provozní: 0 °C až 40 °C na úrovni hladiny
moře

Skladování: -20°C až 60°C na úrovni
hladiny moře

Relativní vlhkost

Provozní: 10%-90% (bez kondenzace)

Skladování: 10%-90% (bez kondenzace)

Nadm. výška

Provozní: 0 - 1499 m při 0°C - 35°C; 1500
- 3000 m při 0°C - 30°C (s aktivním Režim
velké nadm. výš.)

Skladování: 0 - 12200 m při 30°C

Přeprava

Doporučujeme původní nebo ekvivalentní
obal.

Opravy

Přejděte na následující web, zvolte vaši
zemi a v okně se zobrazí kontakt na
nejbližší servis.

<http://www.benq.com/welcome>

Životnost lampy je různá podle podmínek okolního prostředí a podle využití.

ข้อมูลจำเพาะ

(H1)

☞ รายละเอียดทางด้านเทคนิคทั้งหมดอาจเปลี่ยนแปลงได้โดยไม่ต้องแจ้งให้ทราบล่วงหน้า

ระบบออปติค

ความละเอียด

MS531/MS521H: 800 x 600 SVGA

MX532: 1024 x 768 XGA

MW533/TW533: 1280 x 800 WXGA

MH534/TH534: 1920 x 1080 1080p

ระบบแสดงภาพ

1-CHIP DMD

F/Number ของเลนส์

MS531/MX532/MW533/TW533/MS521H

F = 2.46 ถึง 2.66

f = 21.8 ถึง 25.6 มม.

MH534/TH534

F = 2.42 ถึง 2.62

f = 19.0 ถึง 22.65 มม.

ออฟเซต

MS531/MX532/MS521H: 106±5%

MW533/TW533: 104±5%

MH534/TH534: 107±5%

อัตราZoom

1.2X

หลอดไฟ

หลอดไฟขนาด 203 W

ระบบไฟ

แหล่งจ่ายไฟ

AC100-240V, 2.60 A,

50-60 Hz (อัตโนมัติ)

การสิ้นเปลืองพลังงาน

260 W (สูงสุด); < 0.5 W (สแตนด์บาย)

ตัวเครื่อง

น้ำหนัก

MS531/MX532/MS521H: 2.38 กก. (5.24 ปอนด์)

MW533/TW533: 2.41 กก. (5.31 ปอนด์)

MH534/TH534: 2.42 กก. (5.33 ปอนด์)

เชื่อมต่อเอาต์พุต

สัญญาณออก RGB

D-Sub 15 พิน (ตัวเมีย) x 1

ลำโพง

(สเตอริโอ) 2 วัตต์ x 1

เอาต์พุตสัญญาณเสียง

แจ็คเสียง PC x 1

การควบคุม

การควบคุมอนุกรม RS-232

9 พิน x 1

ตัวรับสัญญาณ IR x 1

USB มินิ B x 1

ขั้วต่ออินพุต

สัญญาณเข้าคอมพิวเตอร์

สัญญาณเข้า RGB

D-Sub 15 พิน (ตัวเมีย) x 2

สัญญาณเข้าวิดีโอ

S-VIDEO

พอร์ต มินิ DIN 4 พิน x 1

VIDEO

แจ็ค RCA x 1

สัญญาณเข้า SD/HDTV

อนาล็อก - แจ็คคอมโพเนนต์ RCA x 3

(ผ่านอินพุต RGB)

ดิจิทัล-HDMI x 2

อินพุตสัญญาณเสียง

สัญญาณเสียงเข้า

แจ็คเสียง PC x 1

ข้อกำหนดของสภาพแวดล้อมการทำงาน

อุณหภูมิ

ขณะทำงาน: 0°C-40°C ที่ระดับน้ำทะเล

ขณะเก็บรักษา: -20°C-60°C ที่ระดับน้ำทะเล

ความชื้นสัมพัทธ์

ขณะทำงาน: 10%-90% (ไม่กลั่นตัว)

ขณะเก็บรักษา: 10%-90% (ไม่กลั่นตัว)

ระดับความสูง

ขณะทำงาน: 0-1499 ม. ที่ 0°C-35°C; 1500-3000 ม.

ที่ 0°C-30°C (เมื่อเปิดหมอดอลติจูดสูง)

ขณะเก็บรักษา: 0-12200 ม. ที่ 30°C

การขนส่ง

แนะนำให้ใช้กล่องบรรจุเดิม หรือเทียบเท่า

การซ่อม

โปรดไปที่เว็บไซต์ด้านล่าง และเลือกประเทศของคุณ

เพื่อค้นหาที่ติดต่อของศูนย์บริการ

<http://www.benq.com/welcome>

☞ อายุหลอดจะแตกต่างกันไป ขึ้นอยู่กับเงื่อนไขของสิ่งแวดล้อมและลักษณะการใช้งาน



(TC)

規格



所有規格如有變更，恕不另行通知。

光學

解析度

MS531/MS521H : 800 x 600 SVGA
 MX532 : 1024 x 768 XGA
 MW533/TW533 : 1280 x 800 WXGA
 MH534/TH534 : 1920 x 1080 1080p

顯示系統

I-CHIP DMD

鏡頭光圈值

MS531/MX532/MW533/TW533/MS521H
 F = 2.46 至 2.66
 f = 21.8 至 25.6 mm
 MH534/TH534
 F = 2.42 至 2.62
 f = 19.0 至 22.65 mm

位移

MS531/MX532/MS521H : 106 ± 5%
 MW533/TW533 : 104 ± 5%
 MH534/TH534 : 107 ± 5%

變焦倍率

1.2X

燈泡

203 瓦燈泡

電氣

電源供應

AC100-240V、2.60 A、
 50-60 Hz (自動)

耗電量

260 W (最大) · < 0.5 W (待機)

機械

重量

MS531/MX532/MS521H : 2.38 kg (5.24 lbs)
 MW533/TW533 : 2.41 kg (5.31 lbs)
 MH534/TH534 : 2.42 kg (5.33 lbs)

輸出端子

RGB 輸出

D-Sub 15-pin (母接頭) x 1

喇叭

(立體聲) 2 瓦 x 1

音訊訊號輸出

PC 音訊插孔 x 1

控制

RS-232 序列控制

9-pin x 1

紅外線接收器 x 1

迷你 B 型 USB x 1

輸入端子

電腦輸入

RGB 輸入

D-Sub 15-pin (母接頭) x 2

視訊訊號輸入

S-VIDEO

Mini DIN 4-pin 連接埠 x 1

VIDEO

RCA 插孔 x 1

SD/HDTV 訊號輸入

類比 - 色差視訊 RCA 插孔 x 3
 (透過 RGB 輸入)

數位 - HDMI x 2

音訊訊號輸入

音訊輸入

PC 音訊插孔 x 1

環境需求

溫度

操作：0°C 至 40°C (海平面)

存放：-20°C 至 60°C (海平面)

相對濕度

操作：10%-90% (未凝結)

存放：10%-90% (未凝結)

海拔高度

操作：0°C-35°C 為 0 至 1499 公尺，0°C-
 30°C 為 1500 至 3000 公尺 (啟動高海拔模
 式)

存放：30°C 為 0 至 12200 公尺

搬運

建議使用原本或同材質包裝。

維修

請瀏覽以下網站並選擇所在國家，即可找
 到服務聯絡窗口。

<http://www.benq.com/welcome>

燈泡壽命依使用環境條件及使用方式而有差異。



规格

(SC)

☞ 所有规格如有更改，恕不另行通知。

光学**分辨率**

MS531/MS521H: 800 x 600 SVGA
 MX532: 1024 x 768 XGA
 MW533/TW533: 1280 x 800 WXGA
 MH534/TH534: 1920 x 1080 1080p

显示系统

I-CHIP DMD

镜头光圈值

MS531/MX532/MW533/TW533/MS521H
 F = 2.46 - 2.66
 f = 21.8 - 25.6 mm
 MH534/TH534
 F = 2.42 - 2.62
 f = 19.0 - 22.65 mm

偏移

MS531/MX532/MS521H: 106 ± 5%
 MW533/TW533: 104 ± 5%
 MH534/TH534: 107 ± 5%

变焦倍数

1.2X
 灯泡
 203 W 灯泡

电气**电源**

AC100-240V, 2.60 A,
 50-60 Hz (自动)

功耗

260W (最大) ; < 0.5W (待机)

机械**重量**

MS531/MX532/MS521H: 2.38 kg (5.24 磅)
 MW533/TW533: 2.41 kg (5.31 磅)
 MH534/TH534: 2.42 kg (5.33 磅)

输出接口**RGB 输出**

D-sub 15- 针 (母) x 1

扬声器

(立体声) 2W x 1

音频信号输出

PC 音频插孔 x 1

控制**RS-232 串行控制**

9 针 x 1

红外线接收器 x 1

USB mini-B x 1

输入接口**计算机输入**

RGB 输入

D-sub 15- 针 (母) x 2

视频信号输入

S-VIDEO

Mini DIN 4- 针端口 x 1

VIDEO

RCA 插口 x 1

SD/HDTV 信号输入

模拟 - 分量视频 RCA 插口 x 3
 (通过 RGB 输入)

数字 -HDMI x 2

音频信号输入

音频输入

PC 音频插孔 x 1

环境要求**温度**

操作 : 0°C 至 40°C (海平面)

存放 : -20°C 至 60°C (海平面)

相对湿度

操作 : 10%-90% (未凝結)

存放 : 10%-90% (未凝結)

海拔高度

操作 : 0°C-35°C 為 0 至 1499 公尺 · 0°C-
 30°C 為 1500 至 3000 公尺 (啟動高海拔模
 式)

存放 : 30°C 為 0 至 12200 公尺

搬運

建議使用原本或同材質包裝。

維修

請瀏覽以下網站並選擇所在國家，即可找
 到服務聯絡窗口。

<http://www.benq.com/welcome>

☞ 灯泡使用寿命因环境条件和使用情况不同而存在差异。

(A) 仕様

☞ すべての仕様は予告なしに変更することがあります。

光学

解像度

MS531/MS521H:800 x 600 SVGA
MX532:1024 x 768 XGA
MW533/TW533:1280 x 800 WXGA
MH534/TH534:1920 x 1080 1080p

表示システム

I-CHIP DMD

レンズ F/ 番号

MS531/MX532/MW533/TW533/MS521H
F = 2.46 ~ 2.66
f = 21.8 ~ 25.6 mm
MH534/TH534
F = 2.42 ~ 2.62
f = 19.0 ~ 22.65 mm

偏り

MS531/MX532/MS521H:106 ± 5%
MW533/TW533:104 ± 5%
MH534/TH534:107 ± 5%

ズーム比

1.2X
ランプ
203 W ランプ

電気仕様

電源装置

AC100 ~ 240V, 2.60 A
50-60 Hz (自動)

消費電力

260 W (最大); < 0.5 W (スタンバイ)

機械仕様

重量

MS531/MX532/MS521H:2.38 kg (5.24 lbs)
MW533/TW533:2.41 kg (5.31 lbs)
MH534/TH534:2.42 kg (5.33 lbs)

出力端末

RGB 出力

D-Sub 15 ピン (メス) x 1

スピーカー

(ステレオ) 2 ワット x 1

オーディオ信号出力

PC オーディオジャック x 1

コントロール

RS-232 シリアルコントロール

9 ピン x 1

IR 受信装置 x 1

USB ミニ B x 1

入力端末

コンピュータ入力

RGB 入力

D-Sub 15 ピン (メス) x 2

ビデオ信号入力

S ビデオ

ミニ DIN 4 ピンポート x 1

ビデオ

RCA ジャック x 1

SD/HDTV 信号入力

アナログ - コンポーネント RCA

ジャック x 3

(RGB 入力経由)

デジタル - HDMI x 2

オーディオ信号入力

音声入力

PC オーディオジャック x 1

環境条件

温度

動作: 0 °C -40 °C (海拔)

保管: -20 °C -60 °C (海拔)

相対湿度

動作: 10%-90% (結露しないこと)

保管: 10%-90% (結露しないこと)

高度

動作: 0 ~ 1,499 m (0 °C ~ 35 °C)、1,500 ~ 3,000 m (0 °C ~ 30 °C (高地モードオン)の状態)

保管: 0 ~ 12,200 m (30 °C)

輸送

元の梱包または同等品を推奨します。

修理

以下の Web サイトにアクセスし、お住まいの国を選び、サービス連絡先窓口を検索してください。

<http://www.benq.com/welcome>

☞ ランプの寿命は環境条件および使用率により異なります。

사양

(KO)

☞ 모든 사양은 사전 통보 없이 변경될 수 있습니다.

광학 사양

해상도

MS531/MS521H: 800 x 600 SVGA
 MX532: 1024 x 768 XGA
 MW533/TW533: 1280 x 800 WXGA
 MH534/TH534: 1920 x 1080 1080p

디스플레이 시스템

I-칩 DMD

렌즈 F/값

MS531/MX532/MW533/TW533/MS521H
 F = 2.46 ~ 2.66
 f = 21.8 ~ 25.6 mm
 MH534/TH534
 F = 2.42 ~ 2.62
 f = 19.0 ~ 22.65 mm

오프셋

MS531/MX532/MS521H: 106 ± 5%
 MW533/TW533: 104 ± 5%
 MH534/TH534: 107 ± 5%

줌 비율

1.2X
 램프
 203 W 램프

전기 사양

전원 공급 장치

AC100-240V, 2.60 A,
 50-60 Hz (자동)

소비 전력

260W(최대), <0.5W(대기 전력)

기계 사양

무게

MS531/MX532/MS521H: 2.38 kg (5.24 lbs)
 MW533/TW533: 2.41 kg (5.31 lbs)
 MH534/TH534: 2.42 kg (5.33 lbs)

출력 단자

RGB 출력 단자

D-Sub 15 핀 (암) 1 개

스피커

(스테레오) 2W 1 개

오디오 신호 출력

PC 오디오 잭 1 개

제어

RS-232 직렬 컨트롤

9 핀 1 개

IR 수신기 1 개

미니-B 타입 USB 1 개

입력 단자

컴퓨터 입력 단자

RGB 입력 단자

D-Sub 15 핀 (암) 2 개

비디오 신호 입력

S-VIDEO

미니 DIN 4 핀 포트 1 개

비디오

RCA 잭 1 개

SD/HDTV 신호 입력

아날로그 - 컴포넌트 RCA 잭 3 개
 (RGB 입력을 통해 연결)

디지털 -HDMI 2 개

오디오 신호 입력

오디오 입력

PC 오디오 잭 1 개

환경 요건

온도

작동 온도: 해수면 높이에서 0°C-40°C
 보관 온도: 해수면 높이에서 -20°C-60°C

상대 습도

작동 온도: 10%-90%(비응축)
 보관 온도: 10%-90%(비응축)

고도

작동 온도: 0°C ~ 35°C 에서 0 ~
 1,499 m; 0°C ~ 30°C 에서 1,500 ~
 3,000 m(높게 모드 사용 시)
 보관 온도: 30°C 에서 0 ~ 12,200 m

운반

원래의 포장 상자나 이와 유사한 포장재를
 사용할 것을 권장합니다.

수리하기

아래 웹사이트로 들어가서 해당 국가를 선택하면 서비스 연락처 창이 나타납니다.
<http://www.benq.com/welcome>

☞ 램프 수명은 환경 조건과 사용 방식에 따라 달라집니다.



(AR)

المواصفات

جميع المواصفات عرضة للتغيير دون إخطار.

المواصفات الضوئية

دقة الوضوح

MS531/MS521H: 800 x 600 SVGA

MX532: 1024 x 768 XGA

MW533/TW533: 1280 x 800 WXGA

MH534/TH534: 1920 x 1080p

نظام العرض

1-CHIP DMD

البعد (F)/الرقم البؤري

MS531/MX532/MW533/TW533/

MS521H

التركيز البؤري = ٢,٤٦ حتى ٢,٦٦

التركيز البؤري = ٢,٨ حتى ٢,٦ ملم

MH534/TH534

التركيز البؤري = ٢,٤٢ حتى ٢,٦٢

التركيز البؤري = ١,٩٠ حتى ٢,٦٥ ملم

الإزاحة

MS531/MX532/MS521H: 106±5%

MW533/TW533: 104±5%

MH534/TH534: 107±5%

نسبة التكبير /التصغير

1,2X

المصباح

مصباح ٢٠٣ وات

المواصفات الكهربائية

مصدر الطاقة

تيار متردد ١٠٠-٢٠٤ فولت، ٦,٢٠ أمبير،

٦٠٠-٥٠ هرتز (تلقائي)

استهلاك الطاقة

٢٦٠ وات (حد أقصى) < ٠,٥ وات (في وضع

الاستعداد)

المواصفات الميكانيكية

الوزن

MS531/MX532/MS521H: ٢,٣٨ كجم

(٥,٢٤ رطل)

MW533/TW533: ٢,٤١ كجم (٥,٣١ رطل)

MH534/TH534: ٢,٤٢ كجم (٥,٣٣ رطل)

وحدات الخرج الطرفية

خرج RGB

عدد ١ D-Sub ١٥ دبوس (أنثى)

مكبرات الصوت

عدد ١ (ستيريو) ٢ وات

خرج الصوت

عدد ١ مقيس صوت جهاز الكمبيوتر الشخصي

يختلف عمر المصباح باختلاف الظروف البيئية ومدى الاستخدام.

التحكم

تحكم تسلسلي RS-232

٩ دبابيس جهاز استقبال

عدد ١ مستقبل أشعة تحت الحمراء

عدد ١ منفذ USB منفذ مصغر من النوع B

وحدات الإدخال الطرفية

دخول الكمبيوتر

دخول RGB

عدد ٢ D-Sub ١٥ دبوس (أنثى)

دخول إشارة الفيديو

S-VIDEO

عدد ١ منفذ Mini DIN مزود بأربعة دبابيس

VIDEO

عدد ١ مقيس RCA

دخول إشارة SD/HDTV

تناظري - عدد ٣ مقيس قياسي RCA مكون

(من خلال دخل RGB)

عدد ٢ رقمي-HDMI

دخول إشارة الصوت

مدخل الصوت

عدد ١ مقيس صوت جهاز الكمبيوتر الشخصي

المتطلبات البيئية

درجة الحرارة

في حالة التشغيل: ٤٠-٠ درجة عند مستوى سطح البحر

التخزين: ٦٠-٢٠ درجة عند مستوى سطح البحر

الرطوبة النسبية

في حالة التشغيل: ١٠٪-٩٠٪ (بدون تكثيف)

التخزين: ١٠٪-٩٠٪ (بدون تكثيف)

الارتفاع

في حالة التشغيل: ١٤٩٩-٠ م عند ٣٥-٠ درجة:

١٥٠٠-٣٠٠٠ م عند ٣٠-٠ درجة

(عند تشغيل وضع الارتفاع الشاهق)

التخزين: ١٢٢٠٠-٠ م عند ٣٠ درجة

النقل

يوصى باستخدام الحزمة الأصلية أو ما يعادلها.

الإصلاح

يرجى زيارة موقع الويب أدناه واختيار بلدك

لتصل إلى نافذة بيانات الاتصال بالدعم الفني.

<http://www.benq.com/welcome>



- En For further information, please download User Manual on official website:
<http://www.benq.com/>
- Fr Pour de plus amples informations, veuillez télécharger le Manuel de l'utilisateur sur le site Internet officiel : <http://www.benq.com/>
- De Für weitere Informationen laden Sie bitte die Bedienungsanleitung von der offiziellen Webseite herunter: <http://www.benq.com/>
- It Per ulteriori informazioni, scaricare il manuale utente sul sito web ufficiale:
<http://www.benq.com/>
- Es Para más información, descargue el manual del usuario que encontrará en el sitio web oficial: <http://www.benq.com/>
- Pt Para mais informações, transfira o Manual do Utilizador a partir do website oficial: <http://www.benq.com/>
- Sv För ytterligare information, ladda ner bruksanvisningen från den officiella webbplatsen: <http://www.benq.com/>
- Ru Для получения дополнительной информации загрузите Руководство пользователя с официального веб-сайта: <http://www.benq.com/>
- Nl Download voor meer informatie de gebruikershandleiding van de officiële website: <http://www.benq.com/>
- Pl Aby uzyskać więcej informacji, należy pobrać podręcznik użytkownika z oficjalnej witryny: <http://www.benq.com/>
- Tr Daha fazla bilgi için, lütfen <http://www.benq.com/> adresindeki resmî web sitesinden Kullanım Kilavuzunu indirin.
- Cs Další informace najdete v Uživatelské příručce, kterou lze stáhnout z oficiálních webových stránek: <http://www.benq.com/>
- Th สำหรับข้อมูลเพิ่มเติม โปรดดาวน์โหลดคู่มือผู้ใช้ได้จากเว็บไซต์อย่างเป็นทางการของเรา <http://www.benq.com/>
- Tc 有關詳細訊息，請至官方網站下載使用手冊：<http://www.benq.com/>
- Sc 有关详细信息，请至官方網站下載用戶手冊：<http://www.benq.com/>
- Ja 詳しくは、公式 Web サイト (<http://www.benq.com/>) でユーザーマニュアルをダウンロードしてご確認ください。
- Ko 자세한 내용을 보려면 공식 웹사이트 <http://www.benq.com/>에서 사용 설명서를 다운로드하십시오.

Ar

لمزيد من المعلومات، يرجى تنزيل دليل المستخدم من الموقع الرسمي:

<http://www.benq.com/>

