

## Individual Organizers

LPCV21URM

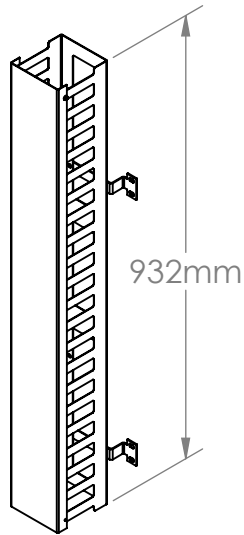

LPCV24URL

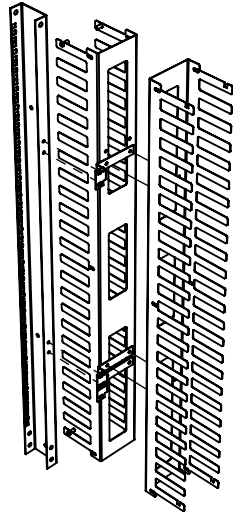
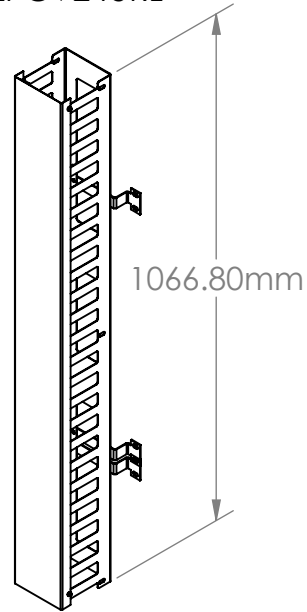

For a double installation, use only 2 pairs of screws and 1 pair of brackets to hold both organizers.

## User Manual Vertical Cable Organizers

LPCV Series Organizers

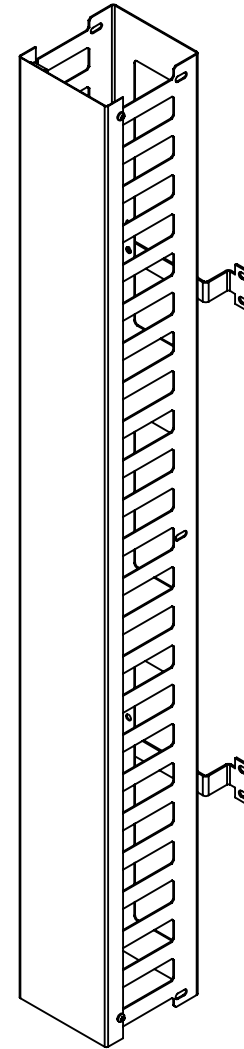

Please read this user manual before using the equipment and retain it for future reference.



**linkedpro**

**SISTEMAS Y SERVICIOS DE COMUNICACIÓN S.A. DE C.V.**  
Calle 20 de Noviembre #805, Col. Centro  
(614) 415-25-25  
C.P. 31000, Chihuahua, Chih, México

## Introducción

Thank you for selecting one of our LPCV Series Rack Cable Organizers. The information contained in this manual will help you in the assembly of the product as well as finding physical characteristics, included parts and recommendations for use.

## Herramienta

Ratch with extension and 7/16" socket

## Modo de Instalación/ Operación

1.-Screw the organizer body to the fixing bracket, taking care that the grooves on the front face down. To choose the organizer perforation.

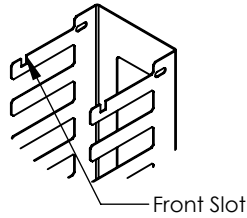

2- Install the retaining brackets over the prepared holes in the back of your EIRL or EIRA Series Rack (not included) using the included screw kit.

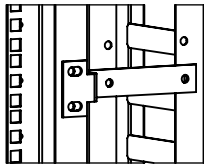

3.- Once you have properly distributed your wiring, position the door following the steps as shown in the image. To remove the lid, first remove the lid from the top organizer and then the bottom.

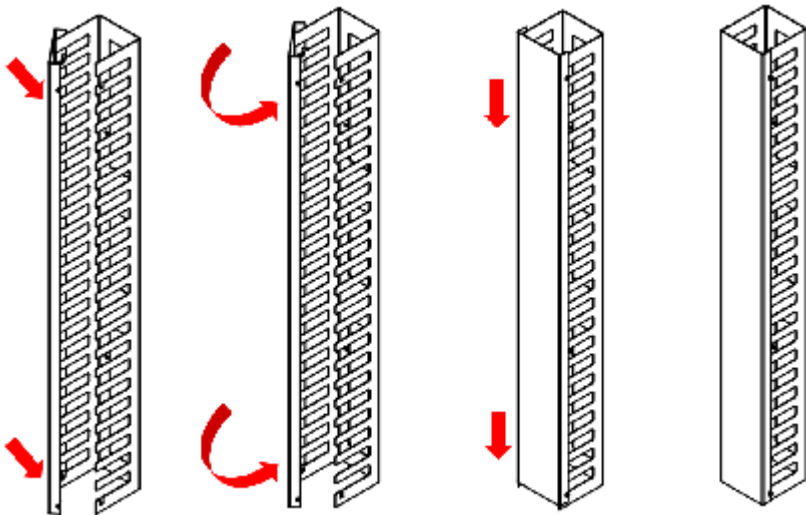

(Does not include racks)

