

Wallbox Power Module

The Wallbox Power Module controls up to six zones of light and will operate the following sources with a continuous Square Law dimming curve or on a full conduction non-dim basis:

- Incandescent
- LED^{1,2}
- Tungsten Halogen
- Electronic Low-Voltage (ELV)³
- Magnetic Low-Voltage (MLV) Transformer
- Metal Halide/High Pressure Sodium Switched
- Neon/Cold Cathode
- Lutron® Tu-Wire® Electronic Fluorescent Dimming Ballasts
- Approved LED and CFL lamps/fixtures
- Up to 64 DALI compliant output devices (devices must comply with IEC/EN 60929) can be addressed and grouped into zones (LQRK-WPM-6D and LQR-WPM-6D only).

The Power Module can be configured for wired, QS link (HomeWorks® QS only), or wireless, RF link (HomeWorks® QS and RadioRA® 2), communication.

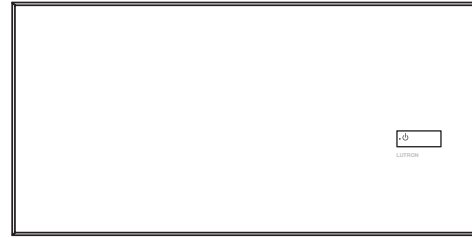

Wallbox Power Module

Models

Model Number	Zones	Voltage	Frequency	Region
HQRJ-WPM-6D-120	6	120 V~, 220-240 V~	434 MHz	U.S.A.
LQRJ-WPM-6P	6	120 V~, 220-240 V~	434 MHz	U.S.A.
LQRK-WPM-6PCE	6	230 V~ CE	868 MHz	Europe/U.A.E.
LQRK-WPM-6D	6	230 V~ CE	868 MHz	Europe/U.A.E.
LQRK-WPM-8D	8	230 V~ CE	868 MHz	Europe/U.A.E.
LQRK-WPM-16D	16	230 V~ CE	868 MHz	Europe/U.A.E.
LQRQ-WPM-6PCE	6	230 V~	434 MHz (Limited Channel)	Hong Kong
LQR-WPM-6PCE	6	230 V~	----	Europe/U.A.E.
LQR-WPM-6P	6	120 V~, 220-240 V~	----	----
LQR-WPM-6D	6	120 V~, 220-240 V~	----	----
LQR-WPM-8D	8	120 V~, 220-240 V~	----	----
LQR-WPM-16D	16	120 V~, 220-240 V~	----	----

NOTES

- Available only in White (WH).
- See page 7 for model number breakdown.

¹ Dimming curve will be dependent on specific LED models.

² For more information on controlling LEDs, please see Application Note #487 on www.lutron.com

³ ELV can be controlled with a smooth, continuous Square Law dimming curve or on a full conduction non-dim basis through a separate Lutron® power module, ELV, or Phase Adaptive power module.

Wallbox Power Module

Specification

Model Numbers	HQRJ-WPM-6D-120, LQRJ-WPM-6P, LQRK-WPM-6PCE, LQRK-WPM-6D, LQRK-WPM-8, LQRK-WPM-16D, LQRQ-WPM-6PCE, LQR-WPM-6PCE, LQR-WPM-6P, LQR-WPM-6D, LQR-WPM-8D, LQR-WPM-16D
Power	120 V~ 50/60 Hz, 220-240 V~ (non CE) (HQRJ-, LQRJ- and LQR- models only) 50/60 Hz, 230 V~ (CE) (LQRK- and LQRQ- models only) 50/60 Hz
Typical Power Consumption	7 W; 0 Power Draw Units (PDUs). The Wallbox Power Module is not powered from the link, Pin 2 should not be connected. Typical Power Consumption test conditions: all loads off, button LED on.
Regulatory Approvals	UL, CSA, FCC, IC, SCT (HQRJ-, LQRJ-, and LQR- models only), CE (all other models), TRA (LQRK- models)
Environment	Ambient operating temperature: 32 °F to 104 °F (0 °C to 40 °C). Ambient operating humidity: 0-90% humidity, non-condensing. Indoor use only.
Communications	Wired (HomeWorks® QS only) - Low-voltage type IEC PELV/NEC® Class 2 wiring connects Wallbox Power Modules to processor. Each HomeWorks® QS processor has two configurable links. Wallbox Power Modules communicate with the processor via the QS link or RF link. RF (RadioRA® 2 and HomeWorks® QS): Lutron® wireless Clear Connect® Technology
ESD Protection	Tested to withstand electrostatic discharge without damage or memory loss, in accordance with IEC 801-2.
Surge Protection	Tested to withstand surge voltages without damage or loss of operation, in accordance with IEEE C62.41-1991 Recommended Practice on Surge Voltages in Low-Voltage AC Power Circuits.
Power Failure	Provides 10-year power failure memory: Automatically restores lighting to levels prior to power interruption.
Mounting	Installs in a standard 4-gang U.S. wallbox, 3½ in (89 mm) deep is strongly recommended. Always allow at least 4½ in (114 mm) clearance above and below the module to provide adequate space for cooling. Wallplate snaps on with no visible means of attachment.
Line Voltage Wiring	Each line voltage terminal can accept one 12 AWG (4.0 mm ²) wire.
IEC PELV/NEC® Class 2 QS System Low-Voltage Wiring (HomeWorks® QS only)	System communication uses low-voltage wiring. Wiring can be daisy-chained or T-tapped. Wiring must be run separately from line/mains voltage. IEC PELV/NEC® Class 2 wiring link requires: Two 18 AWG (0.75 mm ²) conductors for control power. One twisted, shielded pair of 22 AWG (0.34 mm ²) for data link. Available from Lutron, P/N GRX-CBL-346S; check compatibility in your area. Total length of control link must not exceed 2000 ft (610 m).
Warranty	www.lutron.com/TechnicalDocumentLibrary/Warranty.pdf www.lutron.com/TechnicalDocumentLibrary/Intl_Warranty.pdf

Wallbox Power Module

Design Features

- Contains RTISS Equipped® technology to compensate in real time for incoming line voltage variations: No visible flicker with +/-2% change in RMS voltage/cycle and +/-2% Hz change in frequency/second.
- Wallplate snaps on with no visible means of attachment.
- One button for activating default scene.
- Can be configured for wired, QS link (HomeWorks® QS only), or wireless, RF link (HomeWorks® QS and RadioRA® 2), communication.

Dimensions

Dimensions shown as: in (mm)

Front View

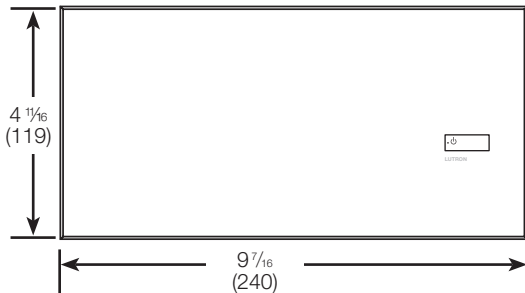

Side View

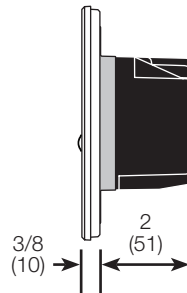

Mounting

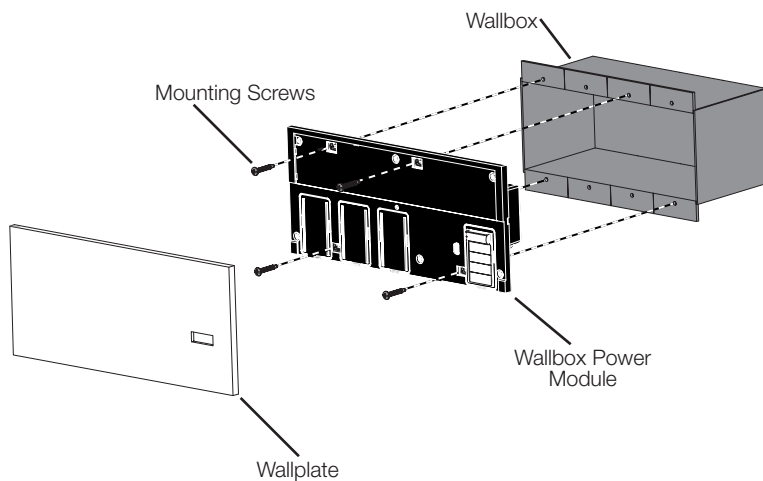

Wallbox Power Module

Load Capacity

	HQRJ-WPM-6D-120, LQRJ-WPM-6P, LQR-WPM-6P		LQRK-, LQRM-, LQRN-, LQRQ, LQR-WPM-6PCE
	120 V~ 50/60 Hz	220-240 V~ 50/60 Hz	230 V~ (CE) 50/60 Hz
Unit Capacity (watts)	2000 W	3000 W	2300 W
Magnetic Low-Voltage	1600 W / 2000 VA	2400 W / 3000 VA	1840 W / 2300 VA
Zone Capacity (watts)	25-800 W	40-1200 W	40-500 W
Magnetic Low-Voltage	25-600 W / 25-800 VA	40-960 W / 40-1200 VA	40-400 W / 40-500 VA
LED	See Application Note #487		

Load Type Notes

(HQRJ-, LQRJ-, and LQR- models only)

- When dimming Electronic Low-Voltage (ELV) lighting, an ELV interface (such as PHPM-PA-DV-WH) must be used with the control unit. Before installing an ELV light source, verify with the manufacturer that their transformer can be dimmed.
- When controlling 0-10 V loads, a Ten Volt Interface (GRX-TVI) must be used with the control unit.
- Not all zones must be connected; however, **connected zones must have a minimum load as specified above.**
- Maximum total lighting load for a Magnetic Low-Voltage (MLV) varies by input voltage **(specified above):**
 - 120 V~ : 800 VA / 600 W
 - 220-240 V~ : 1200 VA / 960 W
- No zone may be loaded with more than the capacity specified above. For higher wattage applications, or for 277 V~ applications, use Lutron® power module PHPM-PA, PHPM-WBX, PHPM-PA-DV, PHPM-SW, or PHPM-WBX-DV.

(LQR-WPM-6PCE, LQRK-, and LQRQ- models only)

- For applications with ELV loads or load wattages exceeding the specified capacities, please refer to specifications for Lutron power modules (NGRX-PB-CE; NGRX-ELVI-CE).
- Not all loads must be connected; however, connected zones must have a minimum load of 40 W.
- Maximum totals lighting load for a magnetic low-voltage zone is 500 VA / 400 W.
- No zone may be loaded with more than 500 W.

Wallbox Power Module

Power and Load Wiring *

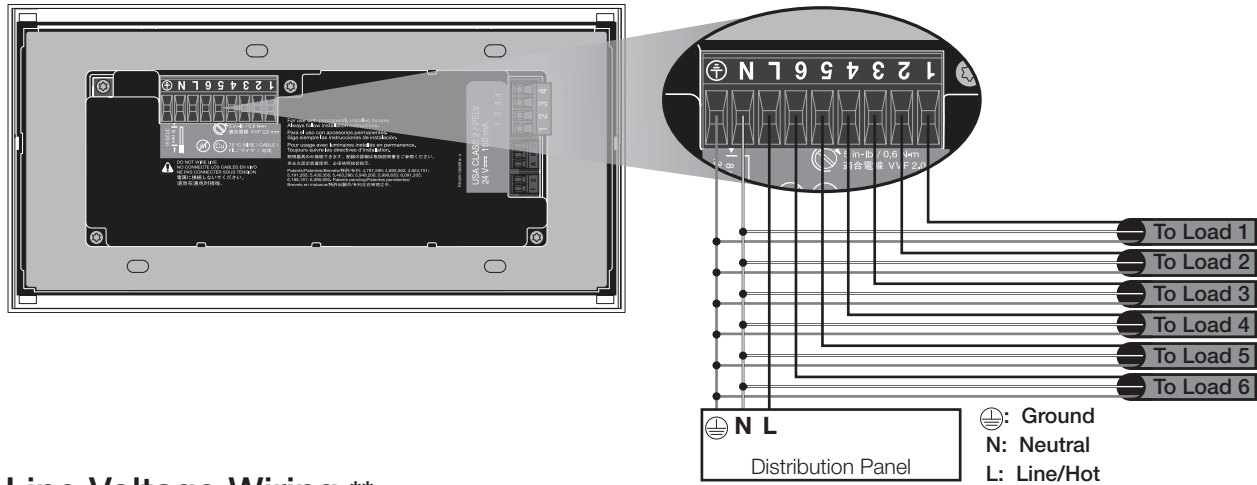

Line Voltage Wiring **

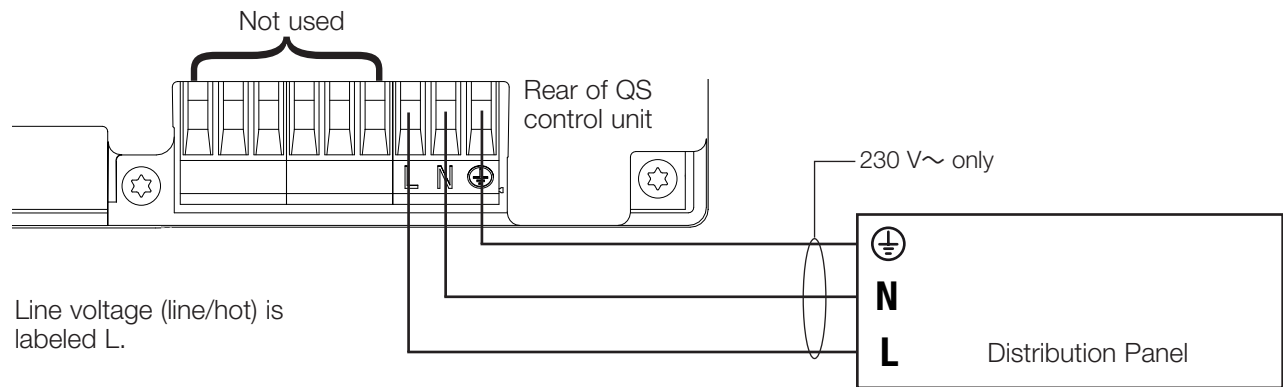

- Pull power wiring from distribution panel and to light fixtures.
- Each line voltage terminal can accept one 12 AWG (4.0 mm²) wire.
- Consult Lutron for non-dim relay wiring and/or load side emergency transfer wiring.

DALI-Compliant Bus Wiring **

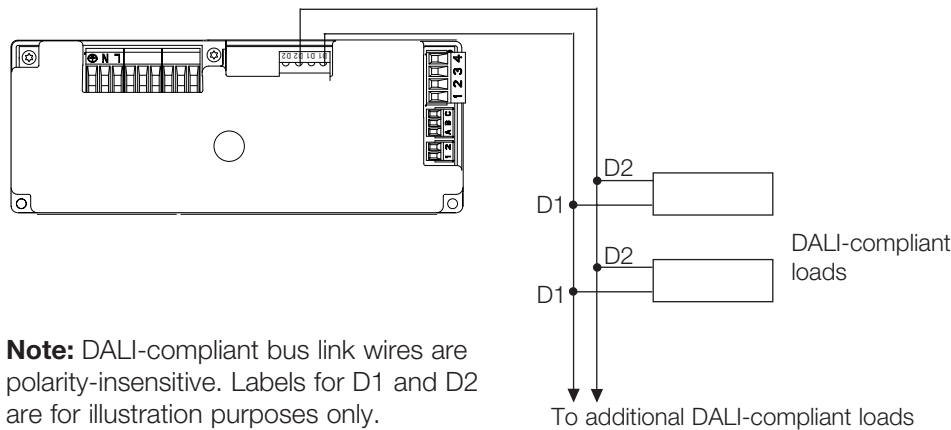

Note: DALI-compliant bus link wires are polarity-insensitive. Labels for D1 and D2 are for illustration purposes only.

* HQRJ-WPM-6D-120, LQRJ-WPM-6P, LQR-WPM-6P, LQRK-WPM-6PCE, LQRQ-WPM-6PCE, LQR-WPM-6PCE models only

** LQR-WPM-6D, LQR-WPM-8D, LQR-WPM-16D, LQRK-WPM-6D, LQRK-WPM-8D, LQRK-WPM-16D models only

Wallbox Power Module

Communications

HomeWorks® QS supports selection of wired or RF communications. A Wallbox Power Module that communicates back to a HomeWorks® QS processor through the RF link should not have any QS wired link connections. In RadioRA® 2 only RF communication is available.

QS Link Wiring (HomeWorks® QS only)

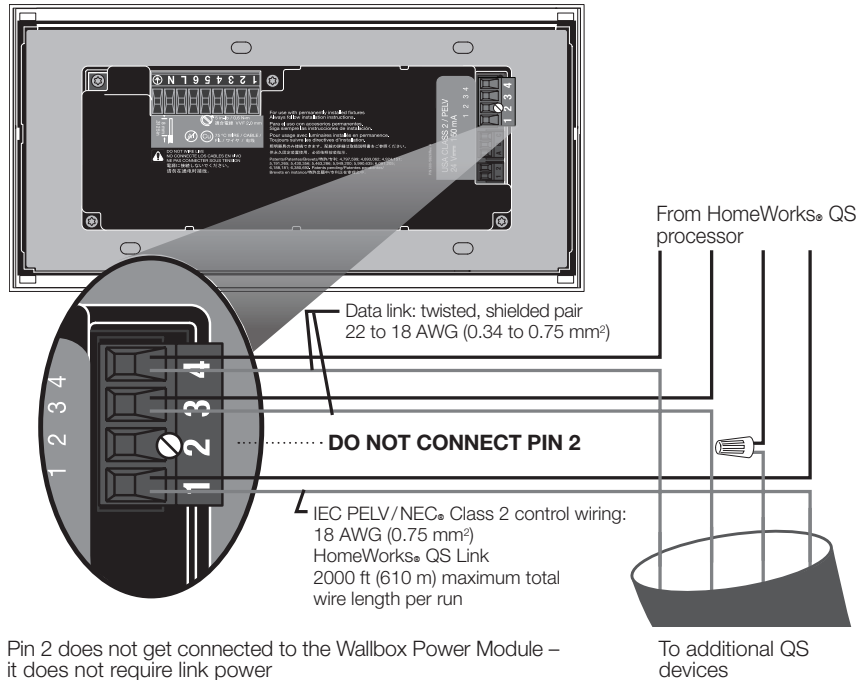

Pin 2 does not get connected to the Wallbox Power Module – it does not require link power

RF Link (RadioRA® 2 and HomeWorks® QS)

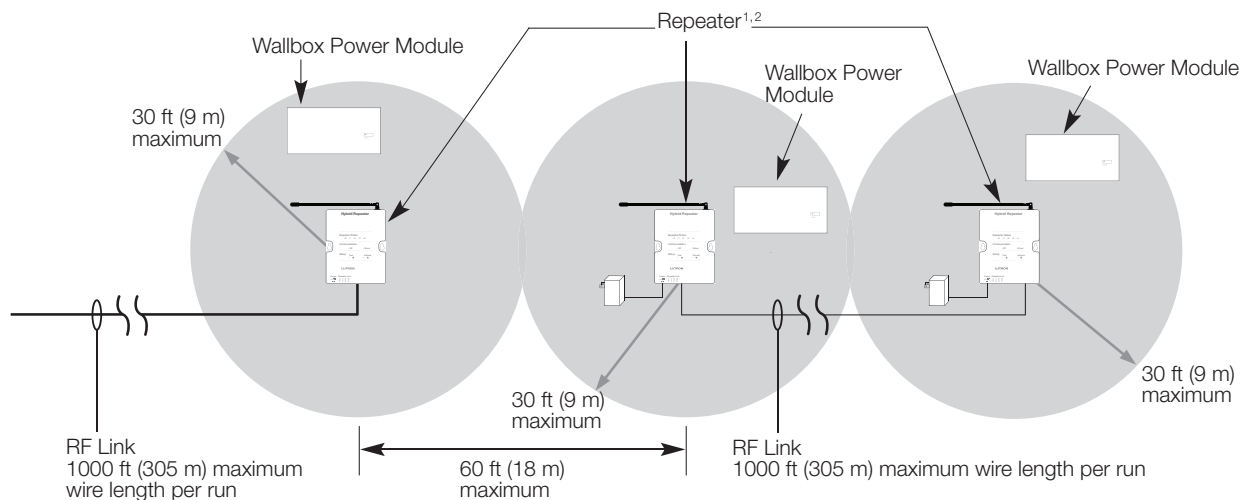

¹ In HomeWorks® QS systems, use Hybrid Repeaters for range extension. In RadioRA® 2, the repeater shown may be either a main repeater (1 required) or auxiliary repeater (up to 4 permitted).

² For reliable RF performance, the Wallbox Power Module should be located at least 6 ft (2 m) away from the main or auxiliary repeater.

Wallbox Power Module

Model Number Breakdown

Phase Control Triac Models:

LQRK – WPM – 6PCE¹

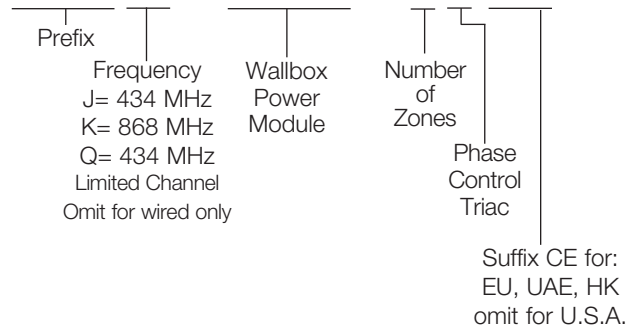

Examples:

- **LQRJ-WPM-6P**
6-zone wallbox power module, phase control triac 434 MHz
- **LQRK-WPM-6PCE**
6-zone wallbox power module, phase control triac 868 MHz

DALI Models:

LQRK – WPM – 6D¹

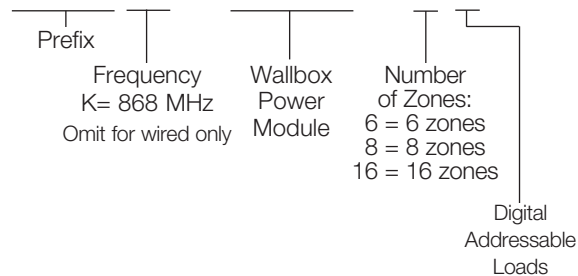

Examples:

- **LQRK-WPM-16D**
6-zone wallbox power module, phase control triac 434 MHz
- **LQRK-WPM-6PCE**
16-zone Wallbox power module, digital addressable loads 868 MHz

¹ See page 1 for available standard model numbers.