

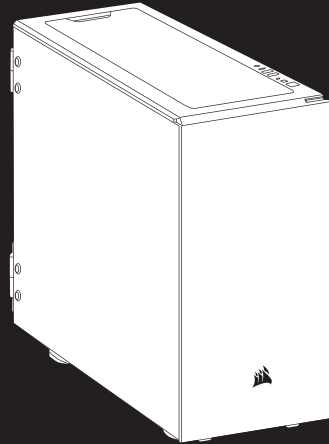

# 678C



WEB: [corsair.com](http://corsair.com)

PHONE: (888) 222-4346

WARRANTY: [www.corsair.com/  
support/warranty](http://www.corsair.com/support/warranty)

SUPPORT: [support.corsair.com](http://support.corsair.com)

BLOG: [corsair.com/blog](http://corsair.com/blog)

FORUM: [forum.corsair.com](http://forum.corsair.com)

YOUTUBE: [youtube.com/corsairhowto](http://youtube.com/corsairhowto)

© 2018-2019 CORSAIR MEMORY, Inc. All rights reserved. CORSAIR and the sails logo are registered trademarks in the United States and/or other countries. All other trademarks are the property of their respective owners. Product may vary slightly from those pictured. 49-001800 AB



CARBIDE SERIES®

# 678C

LOW NOISE ATX CASE



ENGLISH.....	1
FRANÇAIS.....	9
DEUTSCH.....	17
ITALIANO.....	25
ESPAÑOL.....	33
РУССКИЙ.....	41
PORTUGUÊS.....	49

## CASE SPECIFICATIONS

Length.....	549mm
Width.....	239mm
Height.....	497mm
Maximum GPU length.....	370mm
Maximum CPU height.....	170mm
Maximum PSU length.....	225mm

### Fan locations:

Front.....	3x120mm / 2x140mm
Top.....	3x120mm / 3x140mm
Rear.....	1x120mm / 1x140mm
Bottom.....	2x120mm / 2x140mm

### Radiator compatibility:

Front.....	360mm / 280mm
Top.....	420mm* / 360mm
Rear.....	140mm / 120mm

\*Requires ODD to be removed

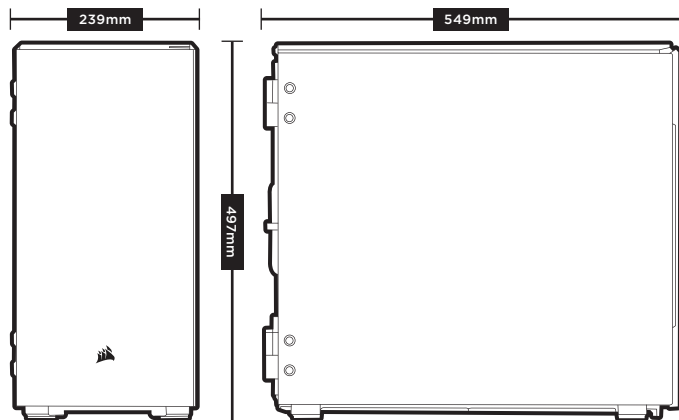

## ACCESSORY KIT CONTENTS

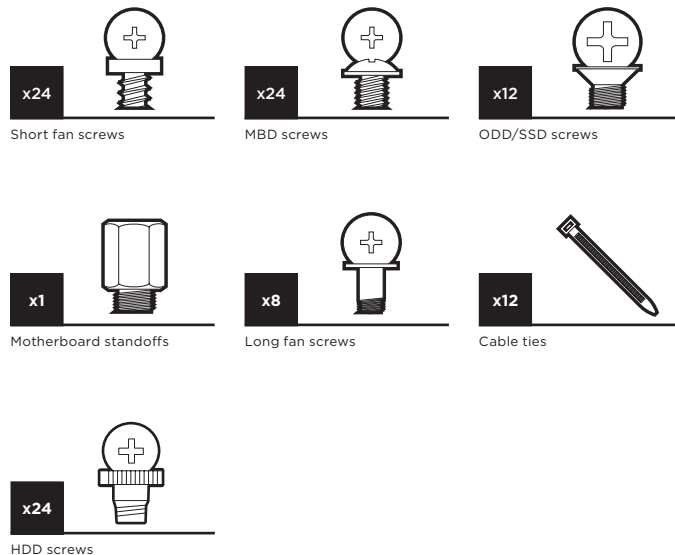

## CASE FEATURES

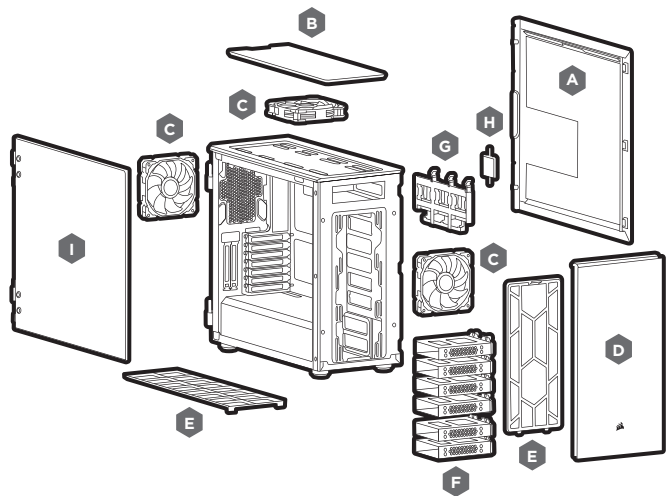

A – Solid side panel with noise damping material

B – Solid top panel with noise damping material

C – 3x 140mm PWM fans

D – Hinged front bezel

E – Dust filters

F – HDD trays

G – SSD trays

H – Fan PWM repeater

I – Tempered glass door

## REMOVING THE SIDE PANELS

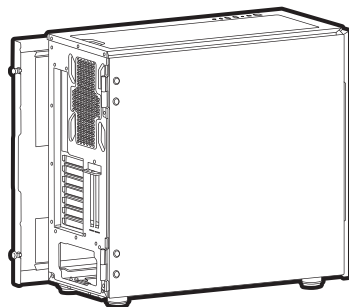

## INSTALLING THE MOTHERBOARD

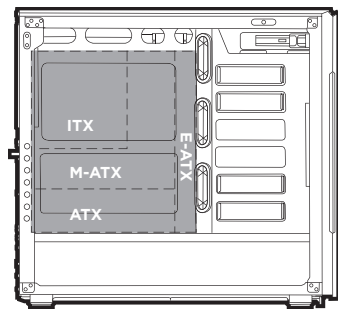

\*E-ATX: 305mm x 280mm

## INSTALLING HDDs

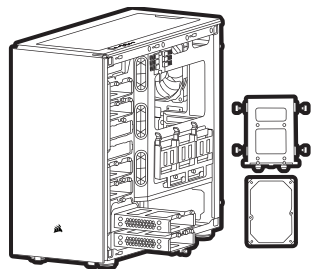

## INSTALLING SSDs

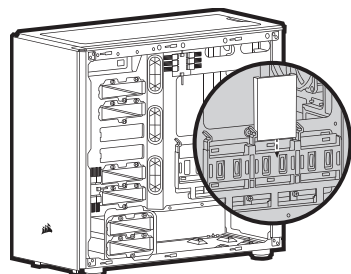

## INSTALLING PSU

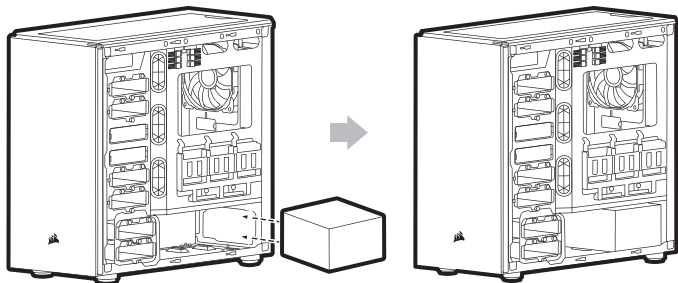

## INSTALLING PCI-e CARDS

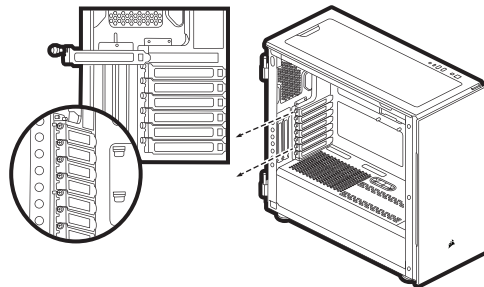

## INSTALLING A 5.25" DRIVE (ODD)

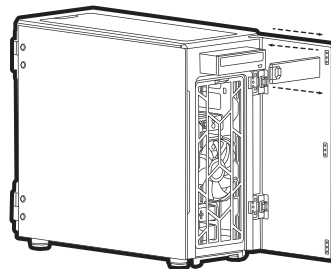

## REMOVING THE FRONT BEZEL

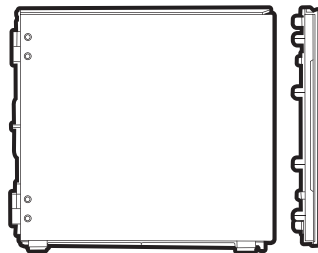

## OPENING FRONT AND SIDE PANELS

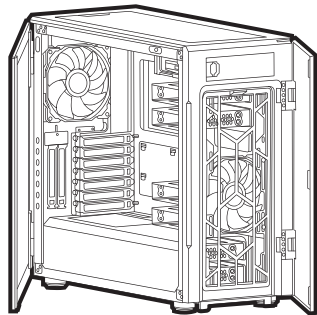

## INSTALLING THE FRONT I/O CONNECTORS

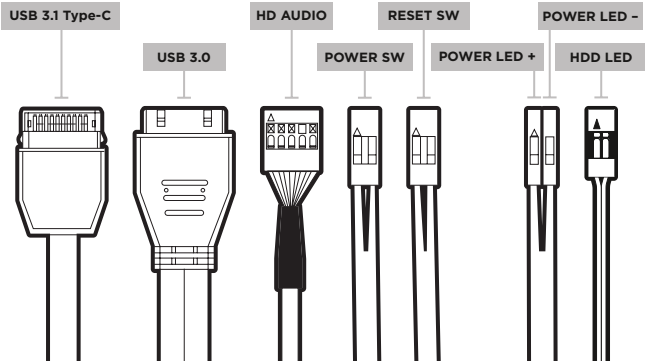

## FAN PWM REPEATER

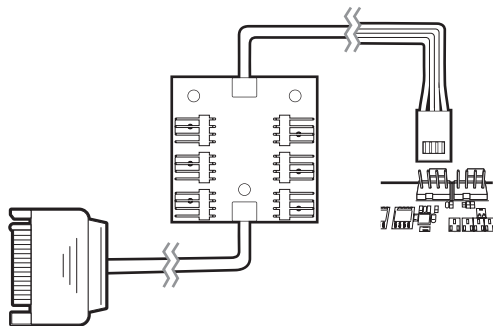

## FREQUENTLY ASKED QUESTIONS

1. Does the polarity matter with the I/O panel's power and reset header?  
No, only the LED headers.
2. Who should I contact if I received my case damaged or one of the fans is no longer working?  
Please go to [support.corsair.com](http://support.corsair.com) and request an RMA so that we can replace the damaged part(s).
3. Where can I mount a fan?

Fan mount locations	
Front	3x120mm / 2x140mm
Top	3x120mm / 3x140mm
Bottom	2x120mm / 2x140mm
Rear	1x120mm / 1x140mm

To learn more about this case visit the product page at [corsair.com](http://corsair.com).

## SPÉCIFICATIONS DU BOÎTIER

Longueur.....	549mm
Largeur.....	239mm
Hauteur.....	497mm
Longueur maximale de carte graphique.....	370mm
Hauteur maximale du processeur.....	170mm
Longueur maximale du bloc d'alimentation.....	225mm

### Emplacements des ventilateurs:

Avant.....	3x120mm / 2x140mm
Haut.....	3x120mm / 3x140mm
Arrière.....	1x120mm / 1x140mm
Bas.....	2x120mm / 2x140mm

### Compatibilité des radiateurs:

Avant.....	360mm / 280mm
Haut.....	420mm* / 360mm
Arrière.....	140mm / 120mm

\*Nécessite que le lecteur optique soit démonté

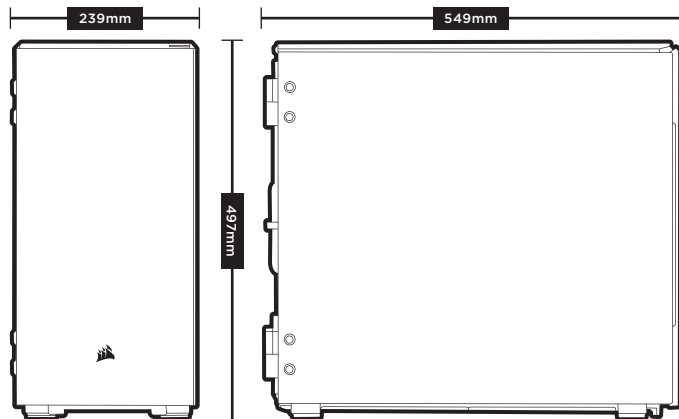

## CONTENU DU KIT D'ACCESSOIRES

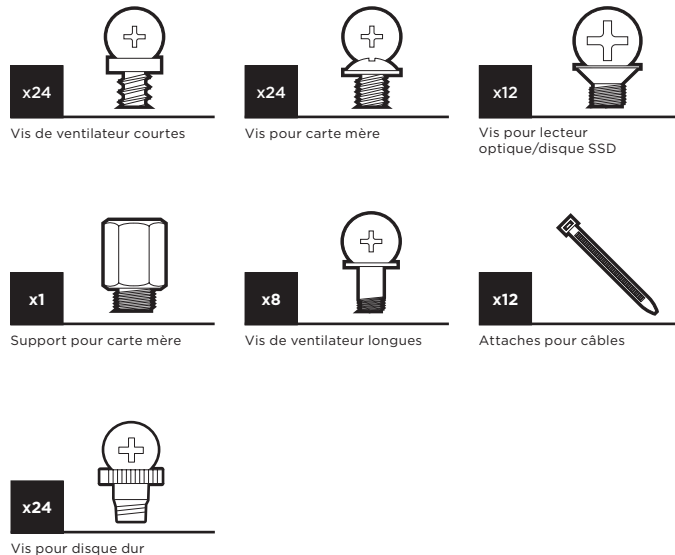

## CARACTÉRISTIQUES DU BOÎTIER

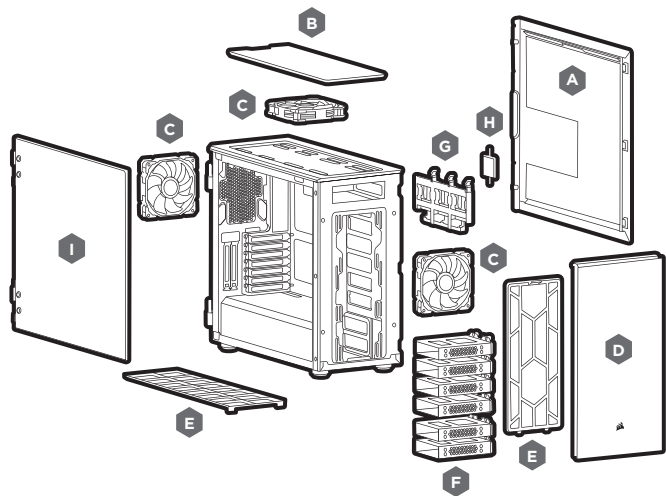

A – Panneau latéral robuste  
avec matériau insonorisant

B – Panneau supérieur robuste  
avec matériau insonorisant

C – 3x Ventilateur PWM de 140 mm

D – Panneau avant articulé

E – Filtre Anti-poussière

F – Plateaux de disque dur

G – Plateaux de disque SSD

H – Répéteur PWM pour ventilateur

I – Porte en verre trempé

## RETRAIT DES PANNEAUX LATÉRAUX

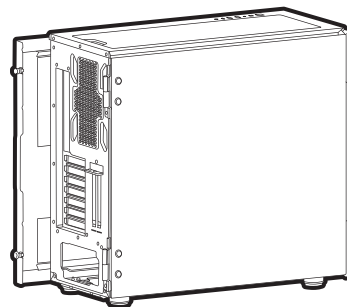

## INSTALLATION DE LA CARTE MÈRE

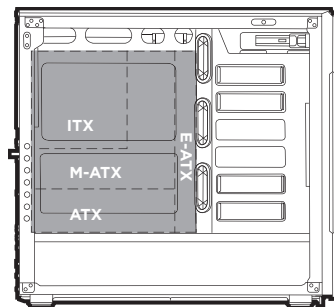

\*E-ATX: 305mm x 280mm



## INSTALLATION DES DISQUES DURS    INSTALLATION DES SSD

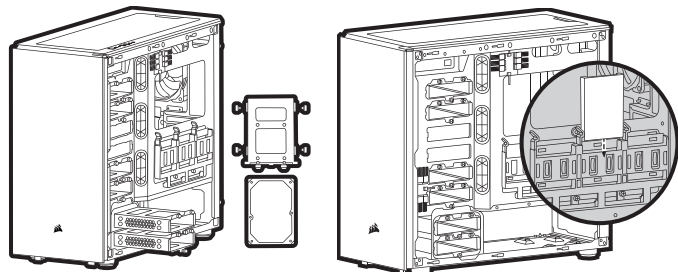

## INSTALLATION DU BLOC D'ALIMENTATION

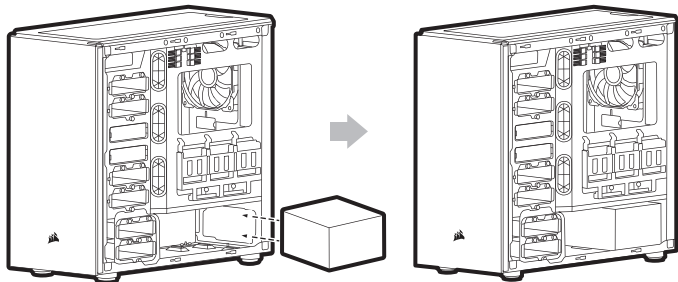

## INSTALLATION DES CARTES PCI-e

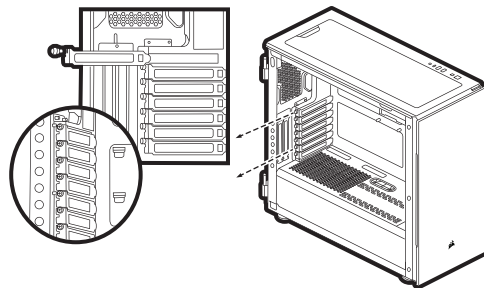

## INSTALLATION D'UN LECTEUR OPTIQUE 5,25''

## RETRAIT DU PANNEAU AVANT

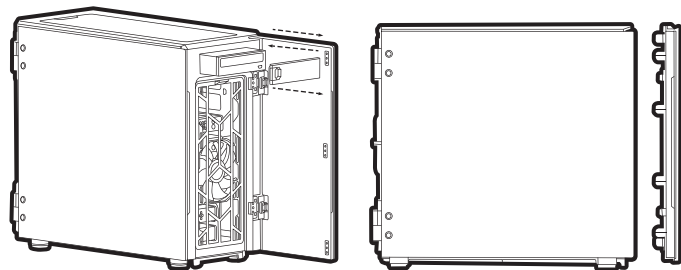

## OUVERTURE DES PANNEAUX LATÉRAUX ET AVANT

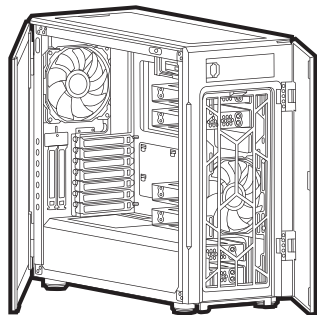

## INSTALLATION DES CONNECTEURS E/S AVANT

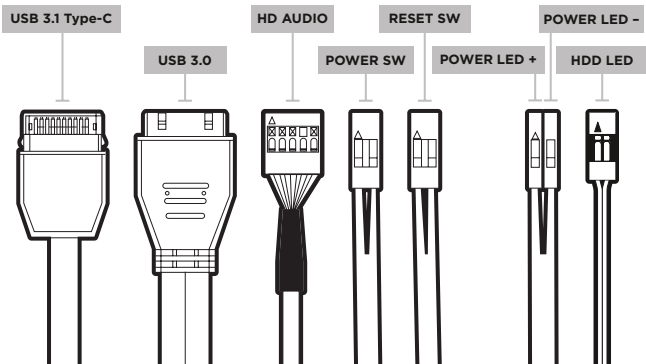

## RÉPÉTEUR PWM POUR VENTILATEUR

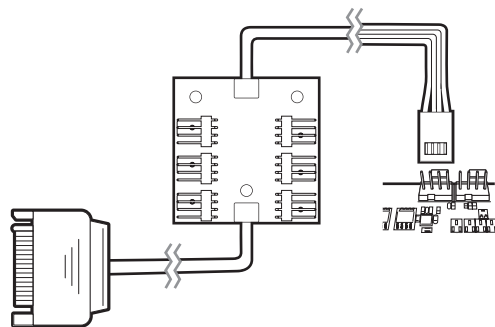

## FOIRE AUX QUESTIONS

1. La polarité est-elle importante pour l'alimentation du panneau d'E/S et le cavalier de réinitialisation?  
Non, uniquement pour les cavaliers à LED.
2. À qui dois-je m'adresser si mon boîtier est endommagé à l'arrivée ou lorsqu'un ventilateur ne fonctionne plus?  
Veuillez vous rendre sur le site [support.corsair.com](http://support.corsair.com) et demandez une RMA (autorisation de retour de marchandise) pour que nous puissions remplacer la ou les pièces endommagées.
3. Où puis-je monter un ventilateur?

Emplacements des fixations de ventilateur	
Avant	3x120mm / 2x140mm
Haut	3x120mm / 3x140mm
Bas	2x120mm / 2x140mm
Arrière	1x120mm / 1x140mm

Pour en savoir plus sur ce boîtier, veuillez vous rendre sur le site [corsair.com](http://corsair.com), à la page des produits.

## TECHNISCHE DATEN DES GEHÄUSES

Länge.....	549mm
Breite.....	239mm
Höhe.....	497mm
Maximale GPU-Länge.....	370mm
Maximale CPU-Höhe.....	170mm
Maximale Netzteil-Länge.....	225mm

### Lüfterpositionen:

Vorderseite.....	3x120mm / 2x140mm
Oben.....	3x120mm / 3x140mm
Rückseite.....	1x120mm / 1x140mm
Unterseite.....	2x120mm / 2x140mm

### Radiatorkompatibilität:

Vorderseite.....	360mm / 280mm
Oben.....	420mm* / 360mm
Rückseite.....	140mm / 120mm

\*Optisches Laufwerk muss entfernt werden

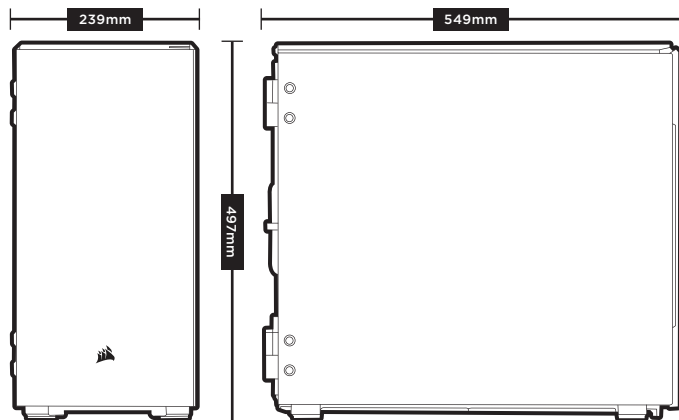

## INHALT DES ZUBEHÖRKITTS

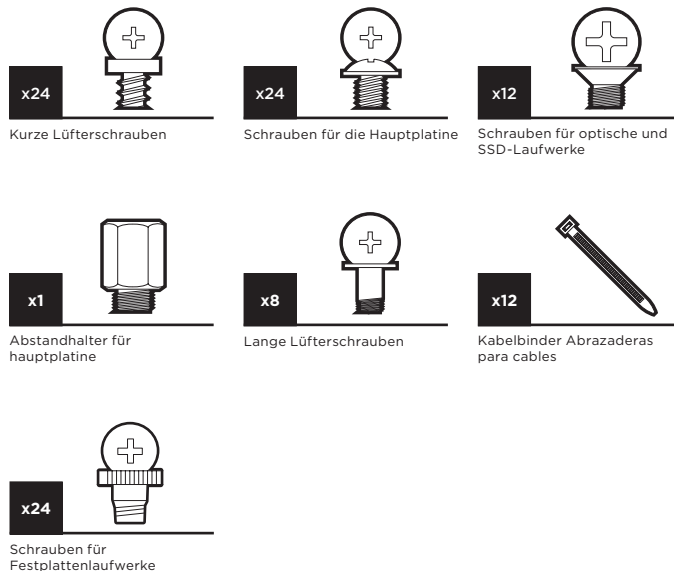

## FUNKTIONSMERKMALE DES GEHÄUSES

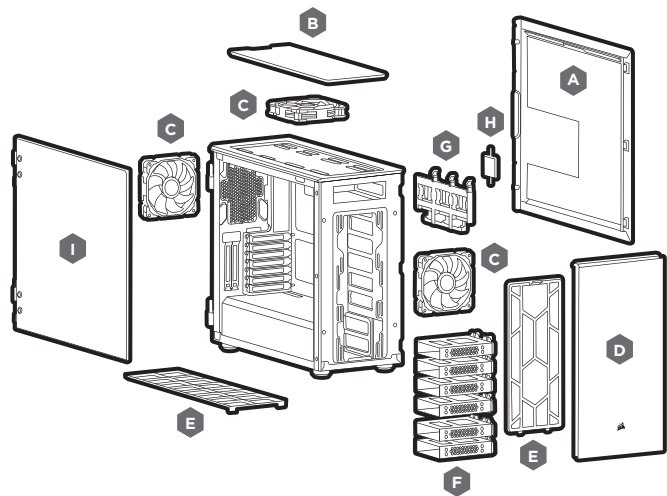

A – Massive Seitenplatte mit schalldämmendem Material

B – Massive obere Abdeckung mit schalldämmendem Material

C – 3× PWM-Lüfter, 140 mm

D – Aufklappbare Vorderblende

E – Staubfilter

F – HDD-Schächte

G – SSD-Schächte

H – Lüfter-PWM-Repeater

I – Tür aus gehärtetem Glas

## ABNEHMEN DER SEITENPLATTEN

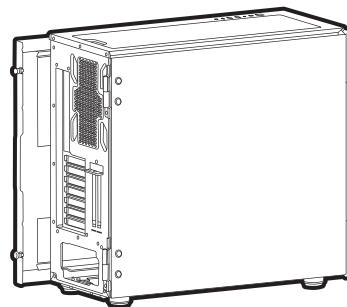

## INSTALLATION DES MOTHERBOARDS

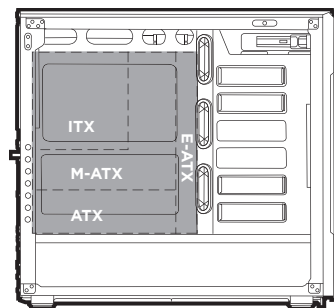

\*E-ATX: 305mm x 280mm

### INSTALLATION VON HDD-LAUFWERKEN

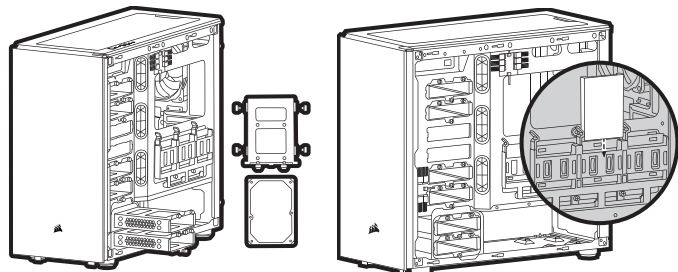

### INSTALLATION VON SSD-LAUFWERKEN

### INSTALLATION DES NETZTEILS (PSU)

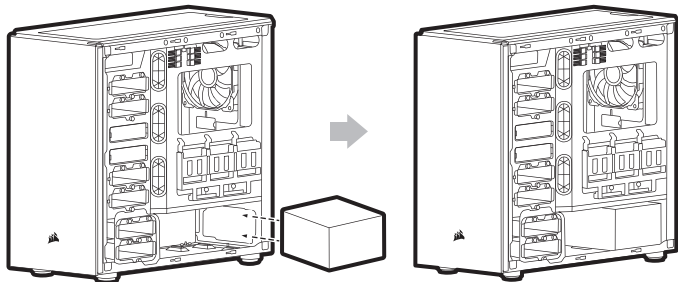

### INSTALLIEREN VON PCI-e-KARTEN

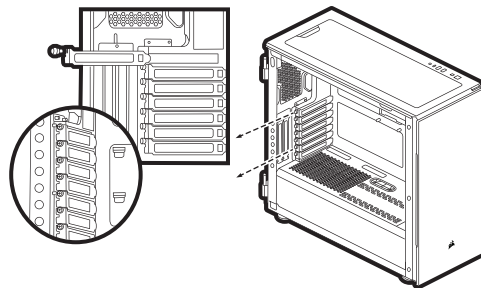

### INSTALLATION EINES 5,25-ZOLL- LAUFWERKS (ODD)

### ABNEHMEN DER VORDEREN BLENDE

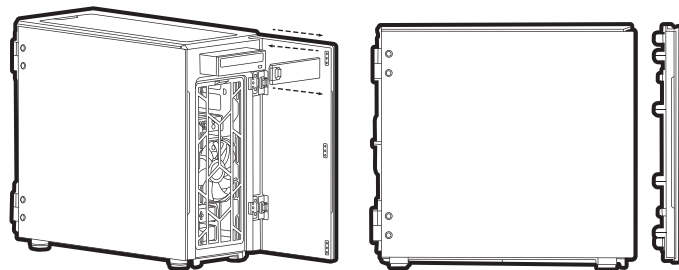

## AUFKLAPPBARE FRONT- UND SEITENABDECKUNG

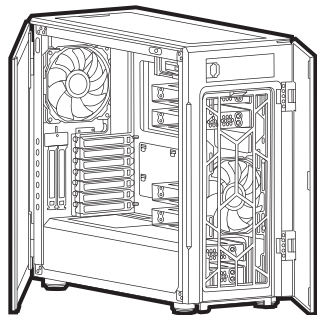

## INSTALLATION DER VORDEREN I/O -ANSCHLÜSSE

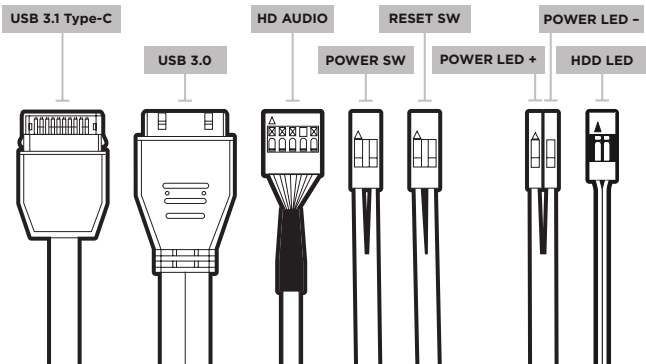

## LÜFTER-PWM-REPEATER

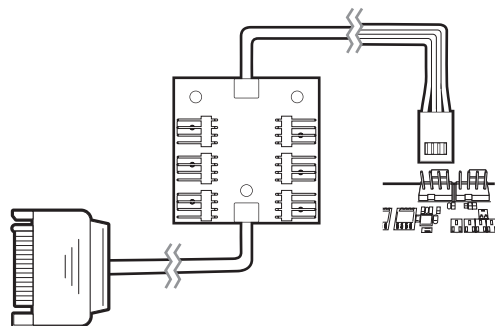

## HÄUFIG GESTELLTE FRAGEN

1. Muss bei der Ein/Austaste und dem Rücksetzschalter der I/O-Abdeckung die Polarität beachtet werden?  
Nein, nur bei den LED-Headern.
2. An wen kann ich mich wenden, wenn ich ein beschädigtes Gehäuse erhalten habe oder einer der Lüfter nicht mehr funktioniert?  
Gehen Sie zu [support.corsair.com](http://support.corsair.com) und fordern Sie eine RMA an, damit wir die beschädigten Teile ersetzen können.
3. Wo kann ich einen Lüfter anbringen?

Lüfter-Einbaupunkte	
Vorderseite	3x120mm / 2x140mm
Oberseite	3x120mm / 3x140mm
Unterseite	2x120mm / 2x140mm
Rückseite	1x120mm / 1x140mm

Weitere Informationen über dieses Gehäuse finden Sie auf der Produktseite bei [corsair.com](http://corsair.com).

## SPECIFICHE CASE

Lunghezza.....	549mm
Larghezza.....	239mm
Altezza.....	497mm
Lunghezza massima GPU.....	370mm
Altezza massima CPU.....	170mm
Lunghezza massima alimentatore.....	225mm

### Posizioni delle ventole:

Anteriore.....	3x120mm / 2x140mm
Superiore.....	3x120mm / 3x140mm
Rear.....	1x120mm / 1x140mm
Inferiore.....	2x120mm / 2x140mm

### Compatibilità radiatore:

Anteriore.....	360mm / 280mm
Superiore.....	420mm* / 360mm
Posteriore.....	140mm / 120mm

\*Richiede ODD da rimuovere

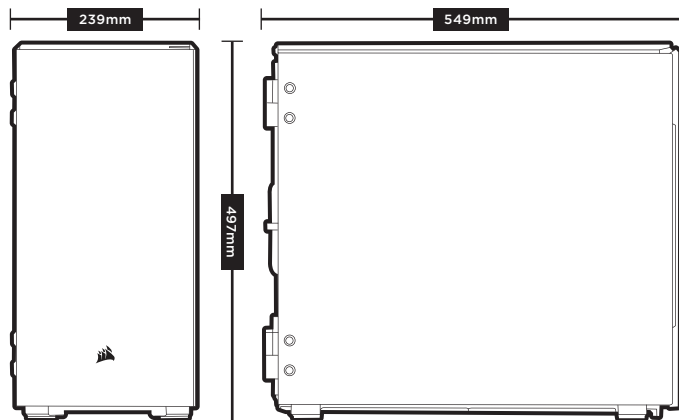

## CONTENUTO KIT DI ACCESSORI

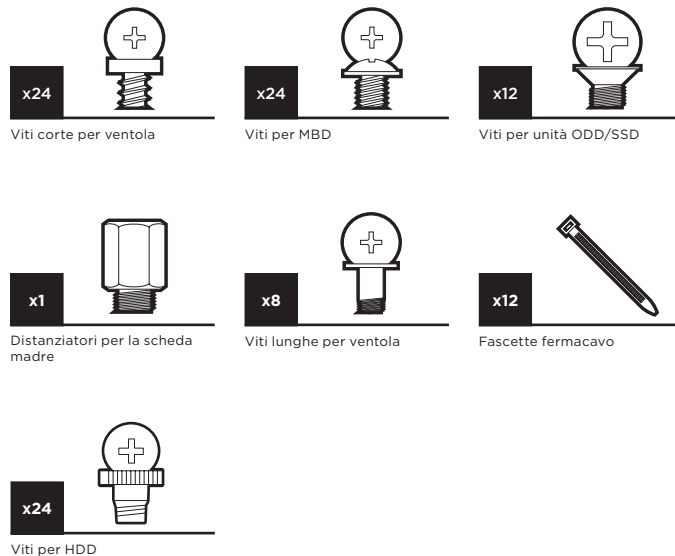

## CARATTERISTICHE CASE

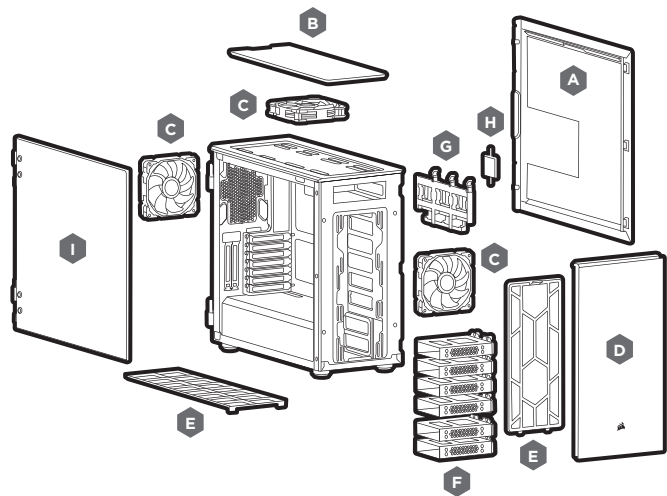

A – Pannello laterale in tinta unita con materiali fonoassorbenti

B – Pannello superiore in tinta unita con materiali fonoassorbenti

C – 3x ventole PWM da 140 mm

D – Pannello anteriore con cerniera

E – Filtri antipolvere

F – Vassoi per unità HDD

G – Vassoi per unità SSD

H – Ripetitore ventola PWM

I – Sportello in vetro temperato

## RIMOZIONE DEI PANNELLI LATERALI

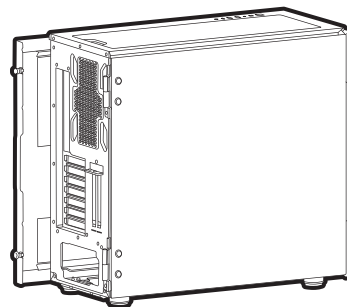

## INSTALLAZIONE DELLA SCHEDA MADRE

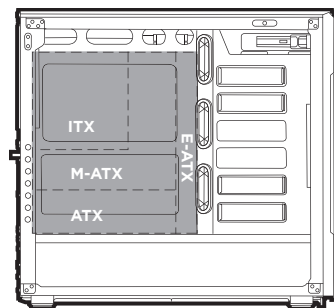

\*E-ATX: 305mm x 280mm



### INSTALLAZIONE DELLE UNITÀ HDD

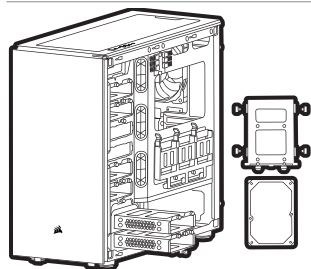

### INSTALLAZIONE DELLE UNITÀ SSD

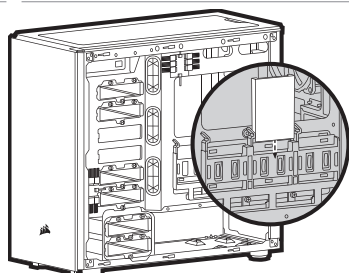

### INSTALLAZIONE DELL'ALIMENTATORE

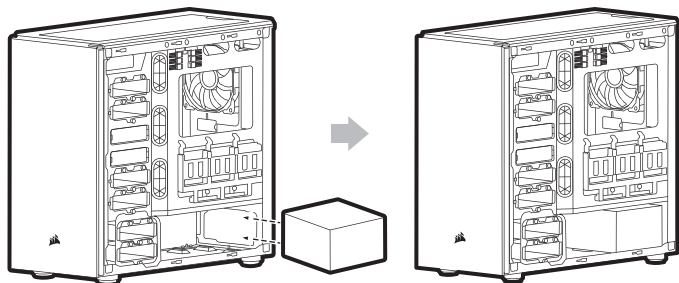

### INSTALLAZIONE DELLE SCHEDE PCI-e

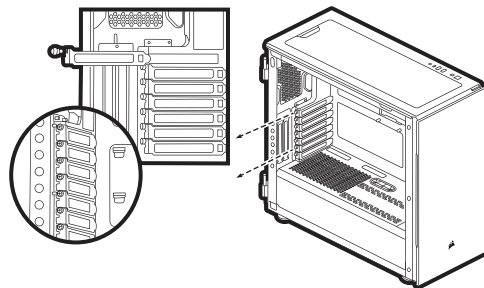

### INSTALLAZIONE DELL'UNITÀ DA 5,25" DRIVE (ODD)

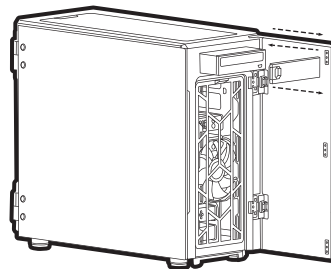

### RIMOZIONE DEL PANNELLO ANTERIORE

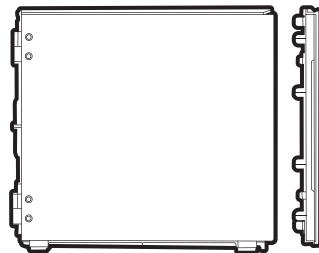

## APERTURA DEI PANNELLI ANTERIORE E LATERALI

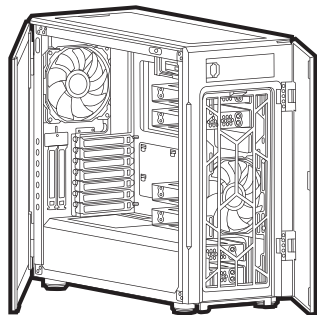

## INSTALLAZIONE DEI CONNETTORI I/O FRONTALI

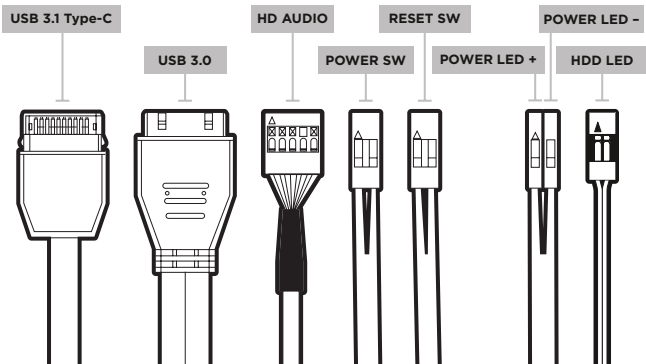

## RIPETITORE VENTOLA PWM

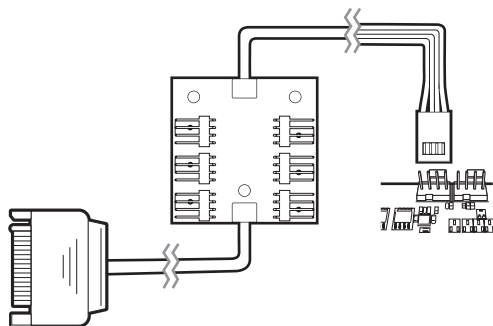

## DOMANDE FREQUENTI

- 1. La questione delle polarità ha a che fare con i connettori di resettaggio e di alimentazione del pannello I/O?**  
No, solo con i connettori LED.
- 2. Chi è necessario contattare se si riceve un case danneggiato oppure se una delle ventole non funziona più?**  
Visitare il sito [support.corsair.com](http://support.corsair.com) e richiedere un RMA in modo da permetterci di sostituire le parti danneggiate.
- 3. Dove è possibile montare una ventola?**

Posizioni di montaggio delle ventole	
Anteriore	3x120mm / 2x140mm
Superiore	3x120mm / 3x140mm
Inferiore	2x120mm / 2x140mm
Posteriore	1x120mm / 1x140mm

Per saperne di più su questo case, visita la pagina del prodotto sul sito [corsair.com](http://corsair.com).

## ESPECIFICACIONES DEL CHASIS

Longitud.....	549mm
Anchura.....	239mm
Altura.....	497mm
Longitud máxima de GPU.....	370mm
Longitud máxima de CPU.....	170mm
Longitud máxima de la PSU.....	225mm

### Ubicación del ventilador:

Delantero.....	3x120mm / 2x140mm
Superior.....	3x120mm / 3x140mm
Posterior.....	1x120mm / 1x140mm
Parte inferior.....	2x120mm / 2x140mm

### Compatibilidad del radiador:

Delantero.....	360mm / 280mm
Superior.....	420mm* / 360mm
Posterior.....	140mm / 120mm

\*Es necesario extraer la unidad de disco óptico

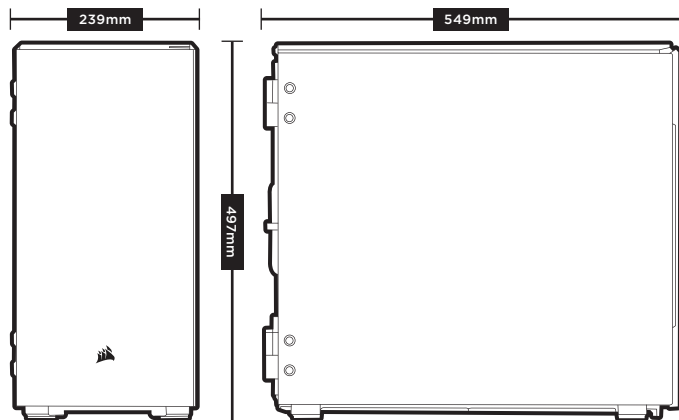

## CONTENIDO DEL KIT DE ACCESORIOS

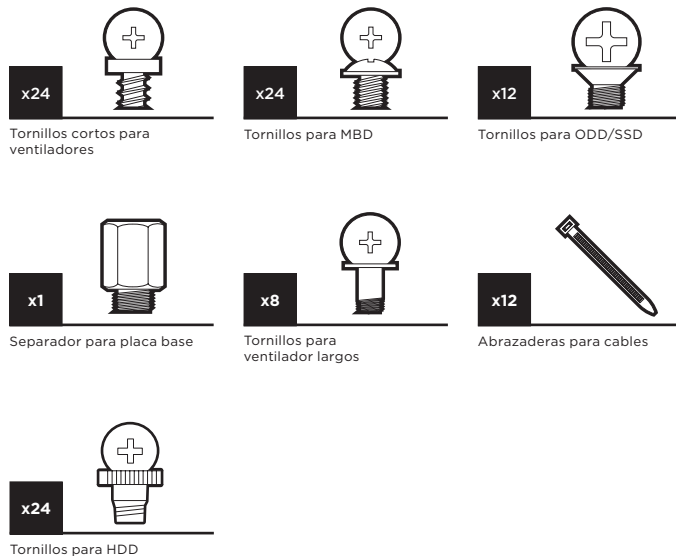

## CARACTERÍSTICAS DEL CHASIS

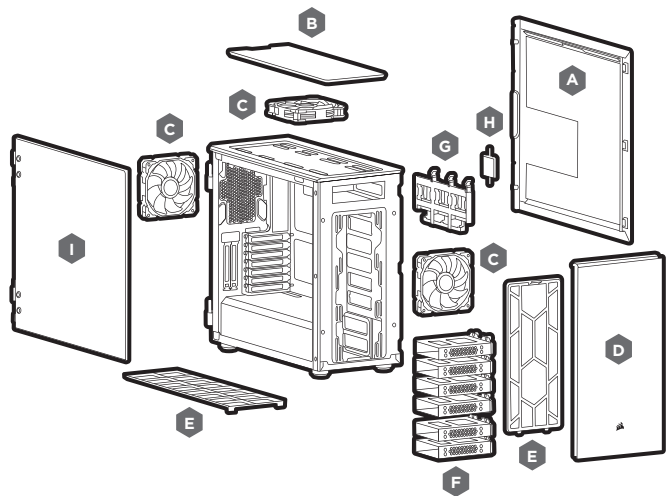

- A — Panel lateral sólido con material de aislamiento acústico
- B — Panel superior sólido con material de aislamiento acústico
- C — 3 Ventiladores PWM de 140 mm
- D — Bisel frontal con bisagras

- E — Filtro antipolvo
- F — Bandejas para HDD
- G — Bandejas para SSD
- H — Repetidor para el PWM del ventilador
- I — Puerta de vidrio templado

## RETIRADA DE LOS PANELES LATERALES

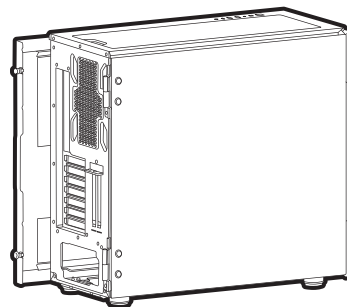

## INSTALACIÓN DE LA PLACA BASE

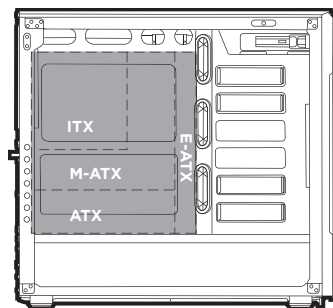

\*E-ATX: 305mm x 280mm

### INSTALACIÓN DE LAS UNIDADES HDD

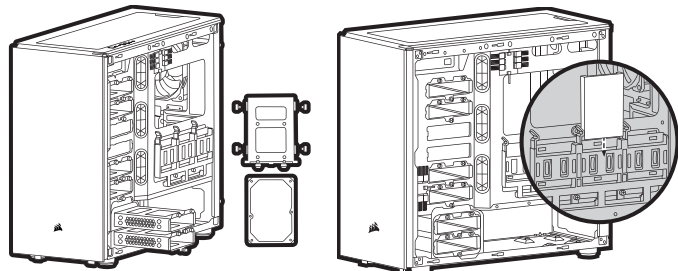

### INSTALACIÓN DE LAS UNIDADES SSD

### INSTALACIÓN DE LA PSU

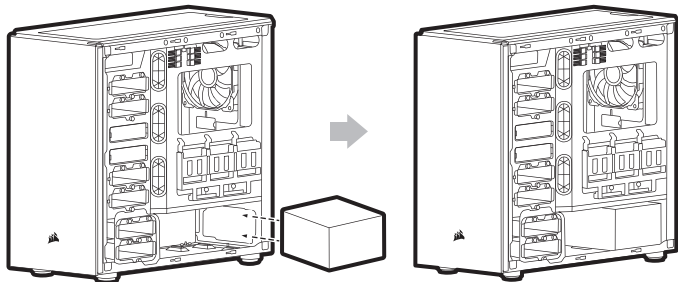

### INSTALACIÓN DE LAS TARJETAS PCI-e

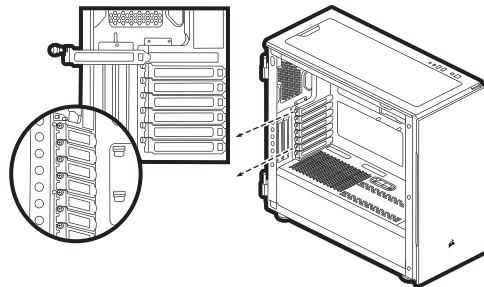

### INSTALAR UNA UNIDAD DE 5,25 PULGADAS (UNIDAD DE DISCO ÓPTICO ODD)

### RETIRADA DEL EMBELLECEDOR FRONTAL

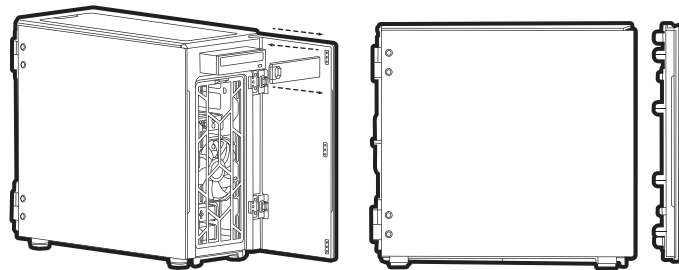

## ABRIR LOS PANELES DEL FRONTAL Y EL LATERAL

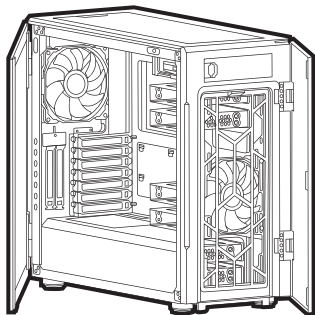

## INSTALACIÓN DE LOS CONECTORES DE E/S FRONTALES

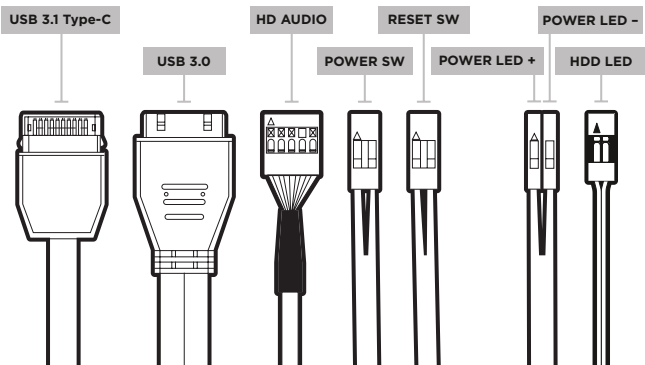

## REPETIDOR PARA EL PWM DEL VENTILADOR

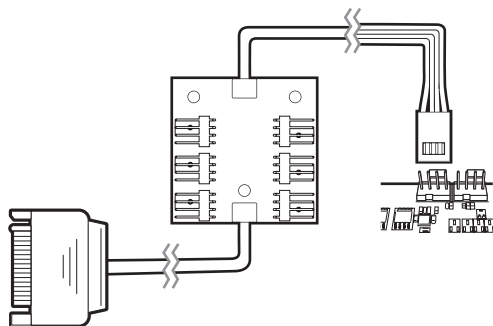

## PREGUNTAS MÁS FRECUENTES

- ¿Hay que tener en cuenta la polaridad con la alimentación y el cabezal de restablecimiento del panel de E/S?  
No, solo los cabezales LED.
- ¿Con quién debo ponerme en contacto si recibo mi chasis dañado o si uno de los ventiladores deja de funcionar?  
Vaya a [support.corsair.com](http://support.corsair.com) y solicite un RMA para que podamos reemplazar las piezas dañadas.
- ¿Dónde puedo montar un ventilador?

Puntos de montaje del ventilador	
Parte delantera	3x120mm / 2x140mm
Parte superior	3x120mm / 3x140mm
Parte inferior	2x120mm / 2x140mm
Parte posterior	1x120mm / 1x140mm

Para obtener más información sobre este chasis, visite la página del producto en [corsair.com](http://corsair.com).

## ТЕХНИЧЕСКИЕ ХАРАКТЕРИСТИКИ КОРПУСА

Длина .....	549mm
Ширина .....	239mm
Высота .....	497mm
Максимальная длина графического процессора .....	370mm
Максимальная высота ЦП .....	170mm
Максимальная длина блока питания .....	225mm

### Расположение вентиляторов:

Спереди .....	3x120mm / 2x140mm
Сверху .....	3x120mm / 3x140mm
Сзади .....	1x120mm / 1x140mm
Снизу .....	2x120mm / 2x140mm

### Совместимость радиаторов:

Спереди .....	360mm / 280mm
Сверху .....	420mm* / 360mm
Сзади .....	140mm / 120mm

\*Привод оптических дисков должен быть снят

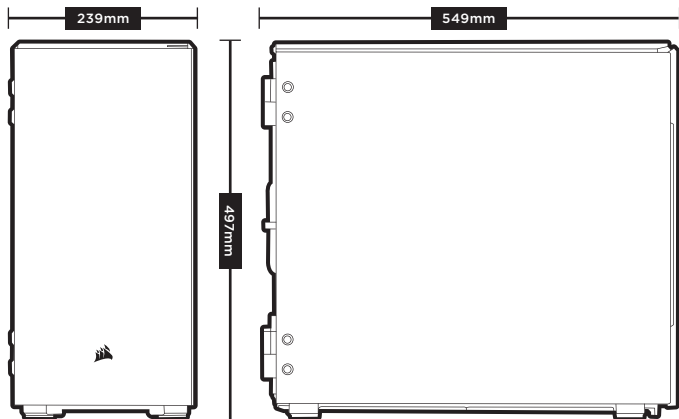

## СОДЕРЖИМОЕ КОМПЛЕКТА АКСЕССУАРОВ

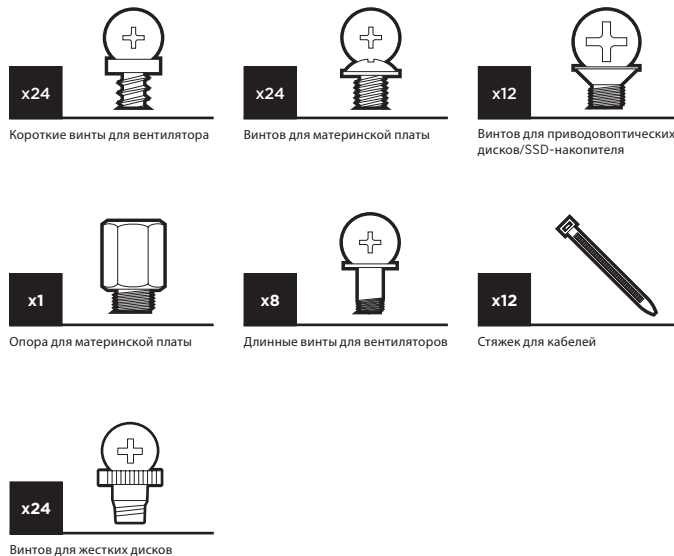

## ОСОБЕННОСТИ КОРПУСА

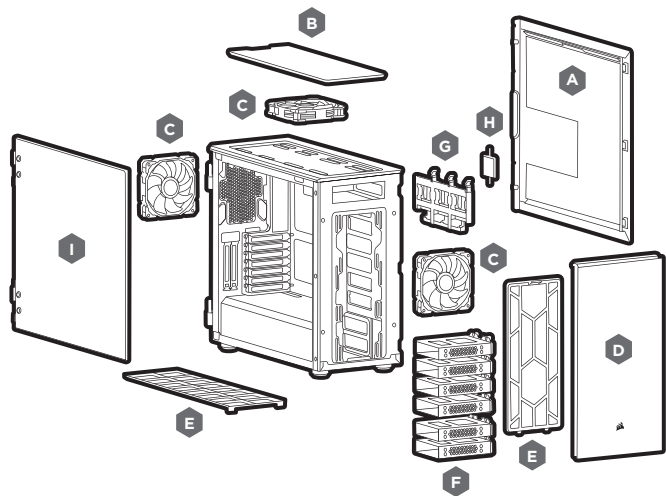

A — Прочная боковая панель с использованием шумоподавляющего материала

B — Прочная верхняя панель с использованием шумоподавляющего материала

C — Три 140-миллиметровых вентилятора с ШИМ-управлением

D — Передний ободок на шарнирах

E — Пылевой Фильтр

F — Лотки для жестких дисков

G — Лотки для твердотельных накопителей

H — Повторитель ШИМ-сигнала вентилятора

I — Дверца из закаленного стекла

## СНЯТИЕ БОКОВЫХ ПАНЕЛЕЙ

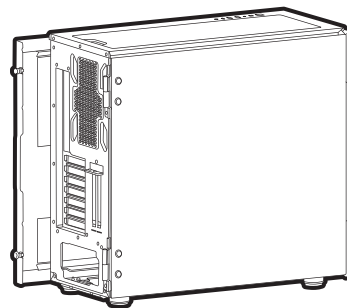

## УСТАНОВКА МАТЕРИНСКОЙ ПЛАТЫ

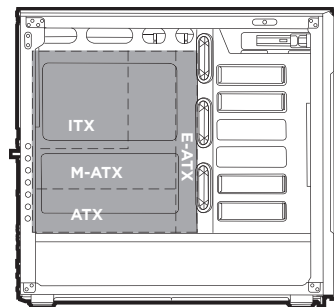

\*E-ATX: 305mm x 280mm

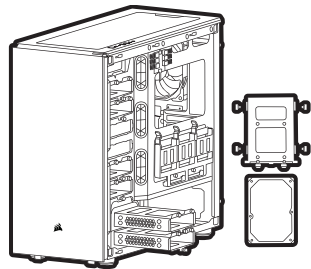
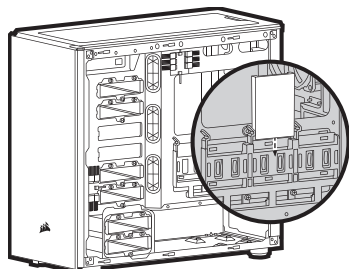

## УСТАНОВКА ЖЕСТКИХ ДИСКОВ

УСТАНОВКА ТВЕРДОТЕЛЬНЫХ  
НАКОПИТЕЛЕЙ

## УСТАНОВКА БЛОКА ПИТАНИЯ

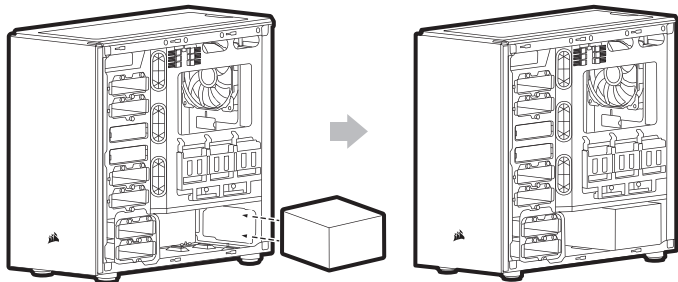

## УСТАНОВКА ПЛАТ PCI-e

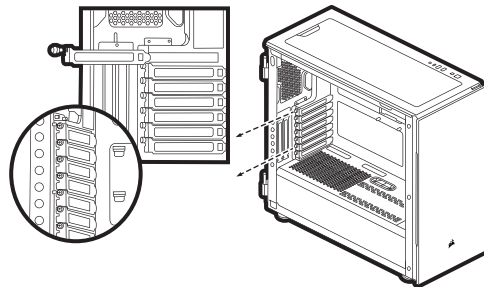
УСТАНОВКА 5,25-ДУЙМОВОГО  
ПРИВОДА ОПТИЧЕСКИХ ДИСКОВ

## СНЯТИЕ ПЕРЕДНЕГО ОБОДКА

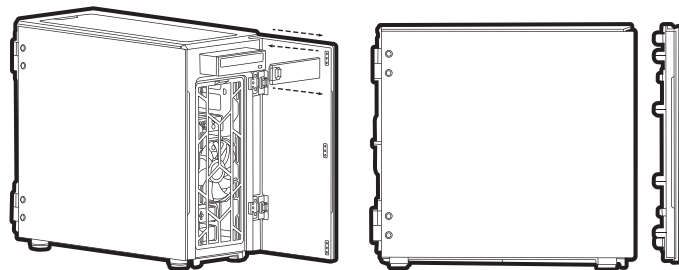

## ОТКРЫВАЮЩАЯСЯ ПЕРЕДНЯЯ И БОКОВЫЕ ПАНЕЛИ

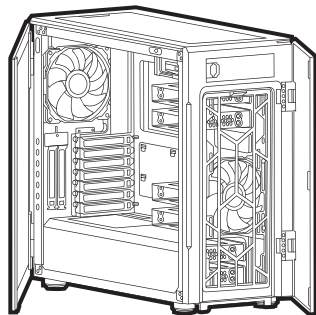

## УСТАНОВКА ПЕРЕДНИХ РАЗЪЕМОВ ВВОДА-ВЫВОДА

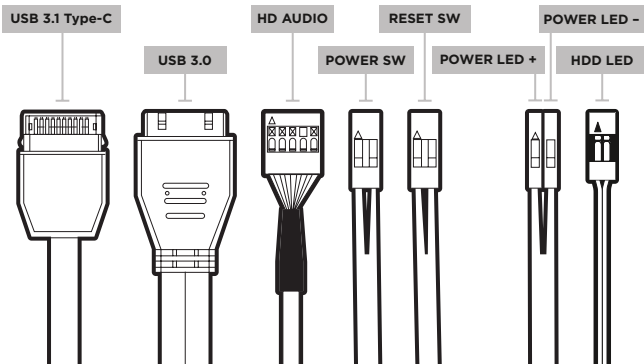

## ПОВТОРИТЕЛЬ ШИМ-СИГНАЛА ВЕНТИЛЯТОРА

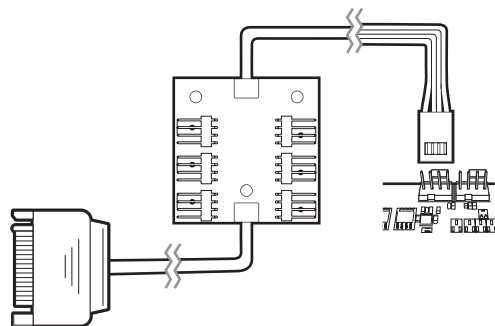

## ЧАСТО ЗАДАВАЕМЫЕ ВОПРОСЫ

1. Имеет ли значение полярность при использовании разъема питания и сброса панели ввода-вывода?  
Нет, она важна только для светодиодных разъемов.
2. К кому следует обратиться, если корпус получен поврежденным или один из вентиляторов не работает?  
Перейдите на веб-сайт [support.corsair.com](http://support.corsair.com) и запросите разрешение на возврат материалов (RMA), чтобы мы смогли заменить поврежденные детали.
3. Где можно установить вентилятор?

Места установки вентиляторов	
Спереди	3x120mm / 2x140mm
Сверху	3x120mm / 3x140mm
Снизу	2x120mm / 2x140mm
Сзади	1x120mm / 1x140mm

Дополнительную информацию об этом корпусе см. на странице продукта на веб-сайте [corsair.com](http://corsair.com).

## ESPECIFICAÇÕES DO GABINETE

Comprimento.....	549mm
Largura.....	239mm
Altura.....	497mm
Comprimento máximo da GPU.....	370mm
Altura máxima da CPU.....	170mm
Comprimento máximo da PSU.....	225mm

### Locais das ventoinhas:

Frente.....	3x120mm / 2x140mm
Topo.....	3x120mm / 3x140mm
Traseira.....	1x120mm / 1x140mm
Parte inferior.....	2x120mm / 2x140mm

### Compatibilidade do radiador:

Frente.....	360mm / 280mm
Topo.....	420mm* / 360mm
Traseira.....	140mm / 120mm

\*Exige a remoção da ODD

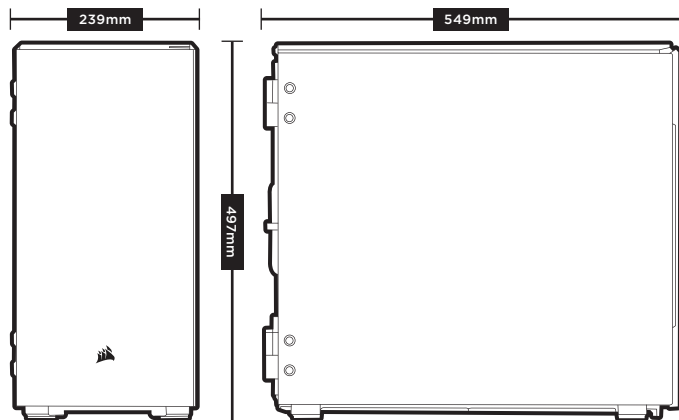

## CONTEÚDO DO KIT DE ACESSÓRIOS

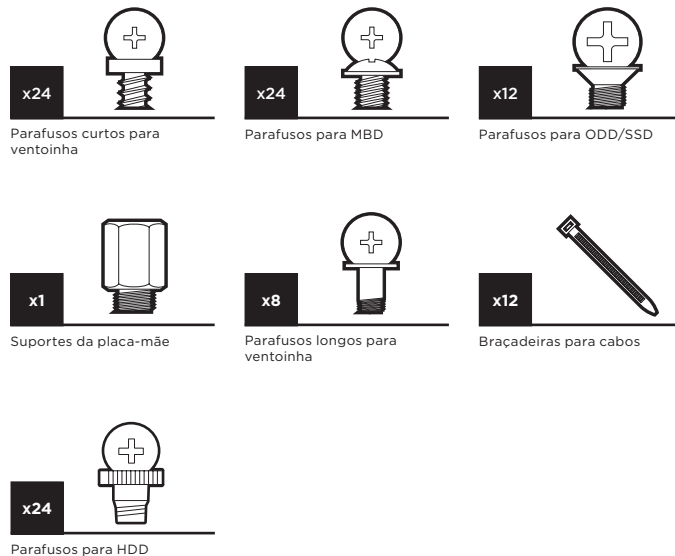

## RECURSOS DO GABINETE

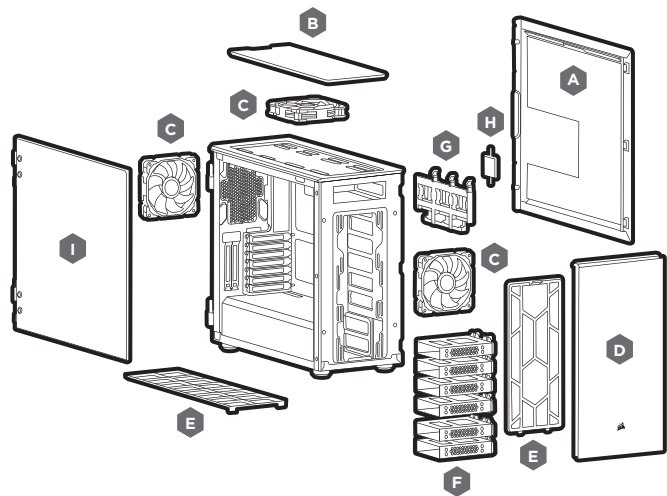

- A — Painel lateral sólido com material antirruido
- B — Painel superior sólido com material antirruido
- C — 3x Ventoinhas PWM de 140 mm
- D — Bisel frontal articulado

- E — Filtro de poeira
- F — Bandejas para HDD
- G — Bandejas para SSD
- H — Repetidor de ventoinha PWM
- I — Porta de vidro temperado

## REMOVER OS PAINÉIS LATERAIS

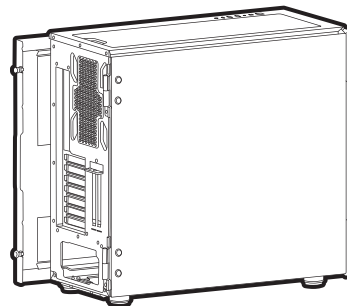

## INSTALAR A PLACA-MÃE

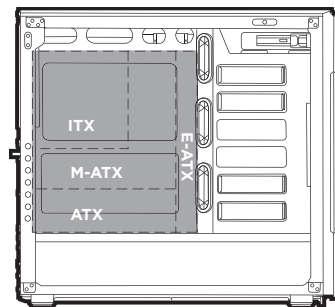

\*E-ATX: 305mm x 280mm

## INSTALAR HDDs

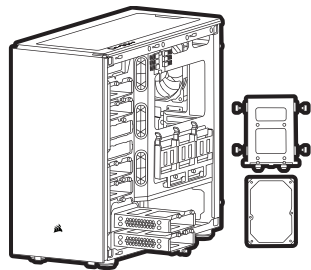

## INSTALAR SSDs

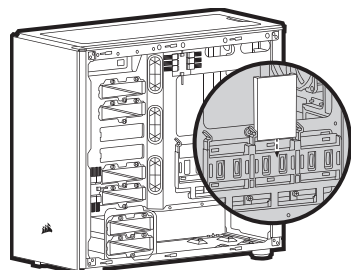

## INSTALAR A PSU

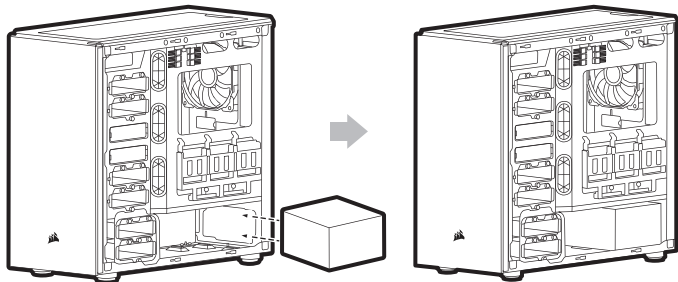

## INSTALAR PLACAS PCI-e

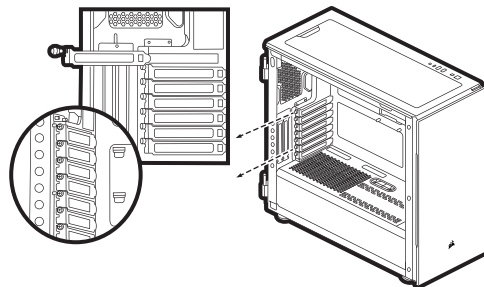

## INSTALAR UMA UNIDADE DE 5,25"

## REMOVER O BISEL DIANTEIRO

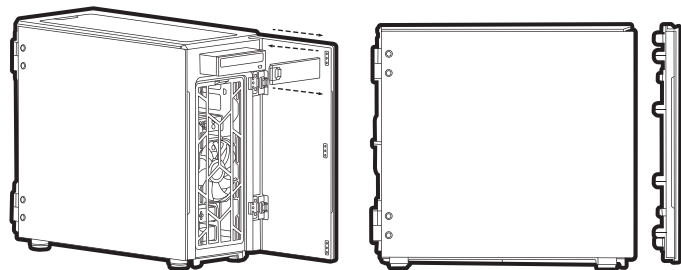

## ABRIR OS PAINÉIS LATERAL E FRONTAL

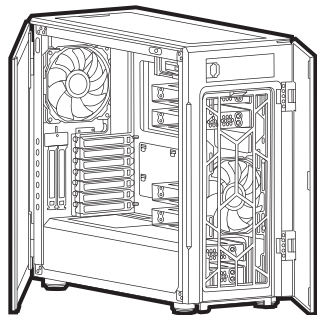

## INSTALAR OS CONECTORES DE E/S DIANTEIROS

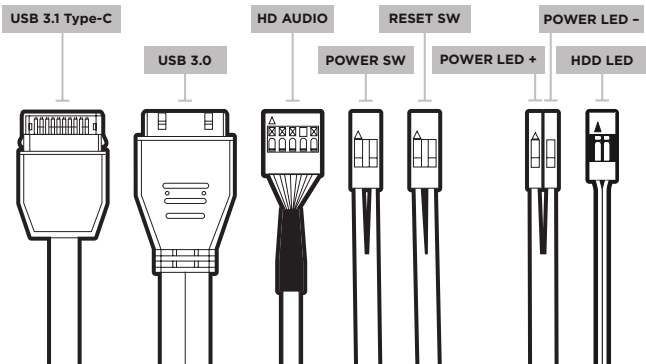

## REPETIDOR DE VENTONHA PWM

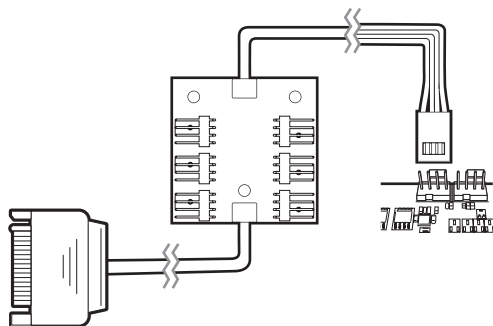

## PERGUNTAS FREQUENTES

1. A polaridade é importante quando o painel de E/S alimenta e reinicia a haste? Não, apenas as hastes do LED.
2. Quem devo contatar caso receba meu gabinete danificado ou uma das ventoinhas não estiver mais funcionando? Acesse [support.corsair.com](http://support.corsair.com) e solicite um RMA, para que possamos substituir a(s) peça(s) danificada(s).
3. Onde posso montar uma ventoinha?

Montar um fã	
Frente	3x120mm / 2x140mm
Topo	3x120mm / 3x140mm
Parte inferior	2x120mm / 2x140mm
Traseira	1x120mm / 1x140mm

Para saber mais sobre este gabinete, visite a página do produto em [corsair.com](http://corsair.com)

**CAUTION!**

The manufacturer is not responsible for any radio or TV interference caused by unauthorized modifications to this equipment. Such modifications could void the user authority to operate the equipment.



This equipment has been tested and found to comply with the limits for a Class B digital device, pursuant to part 15 of the FCC Rules. These limits are designed to provide reasonable protection against harmful interference in a residential installation. This equipment generates, uses and can radiate radio frequency energy and, if not installed and used in accordance with the instructions, may cause harmful interference to radio communications. However, there is no guarantee that interference will not occur in a particular installation. If this equipment does cause harmful interference to radio or television reception, which can be determined by turning the equipment off and on, the user is encouraged to try to correct the interference by one or more of the following measures:

- Reorient or relocate the receiving antenna.
- Increase the separation between the equipment and receiver.
- Connect the equipment into an outlet on a circuit different from that to which the receiver is connected.
- Consult the dealer or an experienced radio/TV technician for help.

This device must not be co-located or operating in conjunction with any other antenna or transmitter.

Operation is subject to the following two conditions:

- (1) This device may not cause harmful interference, and
- (2) This device must accept any interference received, including interference that may cause undesired operation.



CORSAIR MEMORY, Inc. declares that this equipment is compliance with Directive 2011/65/EU. A copy of the original declaration of conformity can be obtained at "regulatory@corsair.com".

CORSAIR MEMORY, Inc. déclare que son équipement est conforme à la directive 2011/65/EU. Une copie de la déclaration de conformité originale peut être obtenue en envoyant un courrier électronique à l'adresse regulatory@corsair.com.

CORSAIR MEMORY, Inc. erklärt, dass dieses Gerät den Richtlinien 2011/65/EU entspricht. Eine Kopie der ursprünglichen Konformitätserklärung kann unter regulatory@corsair.com angefordert werden.

CORSAIR MEMORY, Inc. dichiara che questa apparecchiatura è conforme alla Direttiva 2011/65/EU. Una copia della dichiarazione originale di conformità è disponibile scrivendo un'email all'indirizzo regulatory@corsair.com.

CORSAIR MEMORY, Inc. declara que este equipo cumple con la directiva 2011/65/EU. Puede obtener una copia de la declaración de conformidad original en regulatory@corsair.com.

CORSAIR MEMORY, Inc. declara que este equipamento está em conformidade com as Norma 2011/65/EU. É possível obter uma cópia da declaração original de conformidade pelo e-mail regulatory@corsair.com.

THE AUTHORIZED REPRESENTATIVE IN EUROPE  
CORSAIR MEMORY, BV  
Wormerweg 8, 1311 XB, Almere, Netherlands

LE REPRÉSENTANT AGRÉÉ EN EUROPE  
CORSAIR MEMORY, BV  
Wormerweg 8, 1311 XB, Almere, Netherlands

DIE AUTORISIERTEN VERTRETER IN EUROPA  
CORSAIR MEMORY, BV  
Wormerweg 8, 1311 XB, Almere, Netherlands

IL RAPPRESENTANTE AUTORIZZATO PER L'EUROPA  
CORSAIR MEMORY, BV  
Wormerweg 8, 1311 XB, Almere, Netherlands

EL REPRESENTANTE AUTORIZADO EN EUROPA  
CORSAIR MEMORY, BV  
Wormerweg 8, 1311 XB, Almere, Netherlands

O REPRESENTANTE AUTORIZADO NA EUROPA  
CORSAIR MEMORY, BV  
Wormerweg 8, 1311 XB, Almere, Netherlands

**Note on environmental protection**

After the implementation of the European Directive 2012/19/EU in the national legal system, the following applies:

— Electrical and electronic devices may not be disposed of with domestic waste.

— Consumers are obligated by law to return electrical and electronic devices at the end of their service lives to the public collecting points set up for this purpose of point of sale. Details to this are defined by the national law of the respective country. This symbol on the product, the instruction manual or the package indicates that a product is subject to these regulations. By recycling, reusing the materials or other forms of utilizing old devices, you are making an important contribution to protecting our environment.

**Remarques concernant la protection de l'environnement**

Conformément à la directive européenne 2012/19/EU, et afin d'atteindre un certain nombre d'objectifs en matière de protection de l'environnement, les règles suivantes doivent être appliquées:

— Elles concernent les déchets d'équipement électriques et électroniques. Le pictogramme "pictio" présent sur le produit, son manuel d'utilisation ou son emballage indique que le produit est soumis à cette réglementation.

— Le consommateur doit retourner le produit usager aux points de collecte prévus à cet effet. Il peut aussi le remettre à un revendeur. En permettant enfin le recyclage des produits, le consommateur contribuera à la protection de notre environnement. C'est un acte écologique.

**Hinweis zum Umweltschutz**

Ab dem Zeitpunkt der Umsetzung der europäischen Richtlinie 2012/19/EU in nationales Recht gilt folgendes:

— Elektrische und elektronische Geräte dürfen nicht mit dem Hausmüll entsorgt werden.

— Der Verbraucher ist gesetzlich verpflichtet, elektrische und elektronische Geräte am Ende ihrer Lebensdauer an den dafür eingerichteten, öffentlichen Sammelstellen oder an die Verkaufsstelle zurückzugeben. Einzelheiten dazu regelt das jeweilige Landesrecht. Das Symbol auf dem Produkt, der Gebrauchsanleitung oder der Verpackung weist auf diese Bestimmungen hin. Mit der Wiederverwertung, der stofflichen Verwertung oder anderer Formen der Verwertung von Altgeräten leisten Sie einen wichtigen Beitrag zum Schutz unserer Umwelt. In Deutschland gelten oben genannte Entsorgungsregeln, laut Batterieverordnung, für Batterien und Akkus entsprechend.

**Informazioni per protezione ambientale**

Dopo l'implementazione della Direttiva Europea 2012/19/EU nel sistema legale nazionale, ci sono le seguenti applicazioni:

— I dispositivi elettrici ed elettronici non devono essere considerati rifiuti domestici.

— I consumatori sono obbligati dalla legge a restituire i dispositivi elettrici ed elettronici alla fine della loro vita utile ai punti di raccolta pubblici preposti per questo scopo e nei punti vendita. Dettagli di quanto riportato sono definiti dalle leggi nazionali di ogni stato. Questo simbolo sul prodotto, sul manuale d'istruzioni o sull'imballaggio indicano che questo prodotto è soggetto a queste regole.

**Nota sobre la protección medioambiental**

Después de la puesta en marcha de la Directiva Europea 2012/19/EU en el sistema legislativo nacional, se aplicara lo siguiente:

— Los aparatos eléctricos y electrónicos, así como las pilas y las pilas recargables, no se deben evacuar en la basura común.

— El usuario está legalmente obligado a llevar los aparatos eléctricos y electrónicos, así como pilas y pilas recargables, al final de su vida útil a los puntos de recogida queales o devolverlos al lugar donde los adquirió. Los detalles quedaran definidos por la ley de cada país. El símbolo en el producto, en las instrucciones de uso o en el embalaje hace referencia a ello. Gracias al reciclaje, al reciclaje del material o a otras formas de reciclaje de aparatos usados, contribuye Usted de forma importante a la protección de nuestro medio ambiente.

**Nota em Protecção Ambiental**

Após a implementação da diretiva comunitária 2012/19/EU no sistema legal nacional, o seguinte aplica-se:

— Todos os aparelhos elétricos e eletrônicos não podem ser despejados juntamente com o lixo doméstico.

— Consumidores estão obrigados por lei a colocar os aparelhos elétricos e eletrônicos sem uso em locais públicos específicos para este efeito ou no ponto de venda. Os detalhes para este processo são definidos por lei pelos respectivos países. Este símbolo no produto, o manual de instruções ou a embalagem indicam que o produto está sujeito a estes regulamentos. Reciclando, reutilizando os materiais dos seus velhos aparelhos, esta a fazer uma enorme contribuição para a protecção do ambiente.

**Notitie aangaande de bescherming van het milieu**

Ten gevolge van de invoering van de Europese Richtlijn 2012/19/EU in het nationaal juridisch systeem, is het volgende van toepassing:

— Elektrische en elektronische toestellen mogen niet weggegooid worden tezamen met het huishoudelijk afval.

— Consumenten zijn wettelijk verplicht om elektrische en elektronische apparaten op het einde van gebruik in te dienen bij openbare verzamelaarsplaatsen speciaal opgezet voor dit doeleinde of bij een verkooppunt. Verdere specificaties aangaande dit onderwerp zijn omschreven door de nationale wet van het betreffende land. Dit symbool op het product, de gebruiksaanwijzing of de verpakking duidt erop dat het product onderworpen is aan deze richtlijnen. Doort te recycleren, hergebruiken van materialen of andere vormen van hergebruiken van oude toestellen, levert u een grote bijdrage aan de bescherming van het milieu.



#### Not om miljöskydd

Efter implementeringen av EU direktiv 2012/19/EU i den nationella lagstiftningen, gäller följande:

- Elektriska och elektroniska apparater får inte avyttras med hushållsavfall.
- Konsumenter är skyldiga att återlämna elektriska och elektroniska apparater vid slutet av dess livslängd till, för detta ändamål, specifika uppsamlingsplatser. Detaljer för detta definieras vid den nationella lagstiftningen i respektive land. Denna symbol på produkten, instruktionsmanualen eller på förpackningen indikerar att produkten innefattas av denna bestämmelse. Genom återvinning och återanvändning av material bidrar du till att skydda miljön och din omgivning.

#### Ympäristönsuojelua koskeva ohje

Siitä lähtien, kun Euroopan unionin direktiivi 2012/19/EU otetaan käyttöön kansallisissa lainsäädännöissä, pätevät seuraavat määräykset:

- Sähkö- ja elektroniikkalaitteita ei saa hävittää talousjätteen mukana.
- Kuluttajalla on lain mukaan velvollisuus toimittaa sähkö- ja elektroniikkalaitteet niiden käyttöäin päätyttyä niille varattuihin julkisiin keräyspisteisiin tai palauttaa ne myyntipaikkaan. Tähän liittyvistä yksityiskohtista säädetään kulloisenkin osavaltion laissa. Näistä määräyksistä mainitaan myös tuotteen symbolissa, käyttöohjeissa tai pakkaussessa. Uudelleenkäyttöllä, materiaalien uudelleenkäyttöllä tai muilla vanhojen laitteiden uudelleenkäyttövaihtoilla on tärkeä vaikutus yhteisen ympäristömme suojelemissa.

#### Wskazówki dotyczące ochrony środowiska

Od czasu wprowadzenia europejskiej dyrektywy 2012/19/EU do prawa narodowego obowiązują następujące ustalenia:

- Urządzeń elektrycznych i elektronicznych nie należy wyrzucać wraz z innymi odpadami domowymi.
- Użytkownik zobowiązany jest, niepotrzebne lub zniszczone urządzenia elektryczne oddać do punktu zbiórki lub do sprzedawcy. Szczegółowe kwestie regulują przepisy prawne danego kraju. Informacje o tym symbolu przekreślonego kosza umieszczonego na opakowaniu. Segregując śmieci pomagasz chronić środowisko naturalne.

#### Ochrana životného prostredia

Evropská směrnice 2012/19/EU stanovuje:

- Elektrické a elektronické přístroje se nesmí vyhazovat do domácího odpadu.
- Elektrické a elektronické přístroje musí být zlikvidovány podle zákona na mstech k tomu určených. Recyklaci nebo jiným způsobem zpracování výrazně přispíváte k ochraně našeho životního prostředí!

#### Környezetvédelmi tudnivalók

Az európai irányelvek 2012/19/EU ajánlása szerint, a megjelölt időponttól kezdve, minden EU-s tagállamban érvényesek a következők:

- A leseleztezt elektromos és elektronikus készülékeket nem szabad a háztartási szeméthez dobni.
- Az ehazsnált és мүködésképtelen elektromos és elektronikus készülékek gyűjtésére törvényi előírás kötelez mindenkit, ezért azokat el kell szállítani egy kijelölt gyűjtő helyre vagy visszavinni a vásárlás helyére. A termék csomagolásán feltüntetett szimbólum egyértelmű jelzésként ad erre vonatkozóan a felhasználóknak. A régi készülékek beszüjtése, visszaváltása vagy bármilyen formában történő újra hasznosítása közös hozzájárulás környezetünk védelméhez.

#### Ochrana životného prostredia

Evropská smernica 2012/19/EU stanovuje:

- Elektrické a elektronické zariadenia sa nesmú vyhazovať do domáceho odpadu.
- Spotrebitel je zo zákona povinný zlikvidovať elektrické a elektronické zariadenia na miesta k tomu určené. Symbolizuje to obrázok v návodě na pouzitie, alebo na balení výrobku. Recykláciou, alebo inými formami využitia starých prístrojov prispievate v značnej miere k ochrane nášho životného prostredia.

#### Çevre koruma uyarisi

Avrupa Birliği Direktifi 2012/19/EU ulusal yasal uygulamalar için de geçerli olduğu tarhten itibaren:

- Elektrikli ve elektronik cihazlar normal evsel çöpe atılmamalıdır.
- Tüketici ler için, artik çalismayan elektrikli ve elektronik cihazları, kamuya ait toplama yerlerine götürme veya satın alindikları yerlere geri verme yasal bir zorunluluktur. Bu konu ile ilgili ayrıntılar ulusal yasalarla düzenlenmektedir. Ürün üzerinde, kullandığınız kılavuzunda veya ambalajda bulunan bu sembol tüketiciyi bu konuda uyarır. Eski cihazların geri kazanımı, yapıldıkları malzemelerin değerlendirilmesi veya diğer değerlendirme şekilleri ile, çevre korumasına önemli bir katkıda bulunursunuz. Yukarıda adı geçen adı toplama kuralları Almanya'da piller ve aküler için de geçerlidir.

#### Anvisninger til beskyttelse af miljøet

Efter implementeringen af det europæiske direktiv 2012/19/EU i det nationale lovgivningsystem gælder følgende:

- Elektriske og elektroniske apparater må ikke bortskaffes med husholdningsaffaldet.
- Forbrugeren er ved afslutningen af elektriske og elektroniske apparaters levetid lovmæssigt forpligtet til at aflevere disse på de dertil indrettede offentlige indsamlingssteder eller hos sælgeren. Enkeltheder vedrørende dette fastlægges af de respektive landes nationale lovgivning. Dette symbol på produktet, betjeningsvejledningen eller emballagen viser, at produktet er underlagt disse bestemmelser. Med genanvendelse, genanvendelse af materialer eller andre former for genbrug af gamle apparater yder du et vigtigt bidrag til beskyttelse af vores miljø.



#### Informasjon om beskyttelse av miljøet

Efter implementering av EU-direktiv 2012/19/EU i det nasjonale lovverk, er følgende gjort gjeldende:

- Elektrisk og elektronisk utstyr skal ikke kastes sammen med husholdningsavfall.
- Forbrukere er pålagt ved lov å returnere elektrisk og elektronisk utstyr ved enden av levetiden til offentlige oppsamlingspunkter, oppsatt for dette formål eller til utsalgssteder for slikt utstyr. Detaljer rundt dette er definert i lovverket i det respektive land. Dette symbolet på produktet, bruksanvisningen eller forpakningen forteller at et produkt faller inn under disse betingelsene. Ved riktigulering, gjenbruk av materialet eller på andre måter å nyttiggjøre gammelt utstyr bidrar du på en viktig måte til å beskytte vårt felles miljø!

#### Υπόδειξη σχετικά με την προστασία περιβάλλοντος

Από τη στιγμή που η Ευρωπαϊκή Οδηγία 2012/19/EU ενσωματώνεται στο εθνικό δίκαιο ισχύουν τα εξής:

- Οι ηλεκτρικές και ηλεκτρονικές συσκευές δεν επιτρέπεται να πετιούνται στα σκουπίδια.
- Ο καταναλωτής υποχρεούται διά νόμου να επιστρέφει τις ηλεκτρικές και ηλεκτρονικές συσκευές στο τέλος της ζωής τους στα ειδικά προβλεπόμενα σημεία συγκεντρώνσης ή στα καταστήματα αγοράς. Οι λεπτομέρειες ρυθμίζονται στη σχετική νομοθεσία. Το σύμβολο πάνω στο προϊόν, στο εγχειρίδιο χρήσης ή στη συσκευασία παρέχεται σε αυτές τις διατάξεις. Με την επαναχρησιμοποίηση, την ανακύκλωση των υλικών ή με άλλους τρόπους αξιοποίησης των παλιών συσκευών συμμετέχετε ενεργά στην προστασία του περιβάλλοντος μας. Στη Γερμανία ισχύουν αντίστοιχα οι παραπάνω κανόνες απόρριψης σύμφωνα με τον κανονισμό για μπαταρίες και συσσωρευτές.

#### Охрана окружающей среды

С момента перехода национального законодательства на европейские нормы 2012/19/EU действительны следующие:

- Электрические и электронные приборы запрещается утилизировать вместе с обычным мусором.
- Потребитель, согласно закону, обязан утилизировать электрические и электронные приборы в специально предназначенных для этого пунктах сбора, либо пунктах продажи. Детальная регламентация этих требований осуществляется соответствующим местным законодательством. Необходимость соблюдения данных предписаний обозначается особым знаком на изделии, инструкции по эксплуатации или упаковке. При переработке, повторном использовании материалов или при другой форме утилизации бывших в употреблении приборов особое внимание уделяйте охране окружающей среды. В соответствии с предписаниями по обращению с батареями, в Германии вышеназванные нормы действуют для утилизации батарей и аккумуляторов.