

GAMING CHAIR MOD. YFRD-042920  
**RYUJI DESERT CAMO**  
SERIES 2500

# USER'S MANUAL

MANUAL DE USUARIO

ERGONOMIC  
**DESIGN**  
DISEÑO ERGONÓMICO

BUTTERFLY  
**MECHANISM**  
MECANISMO MARIPOSA

SUPPORTS UP TO  
**330lbs**  
SOPORTA HASTA 150kg

# SPECIFICATIONS

## ESPECIFICACIONES



### GAMING CHAIR **MOD.YFRD-042920**

# *RYUJI DESERT CAMO*

## SERIE 2500

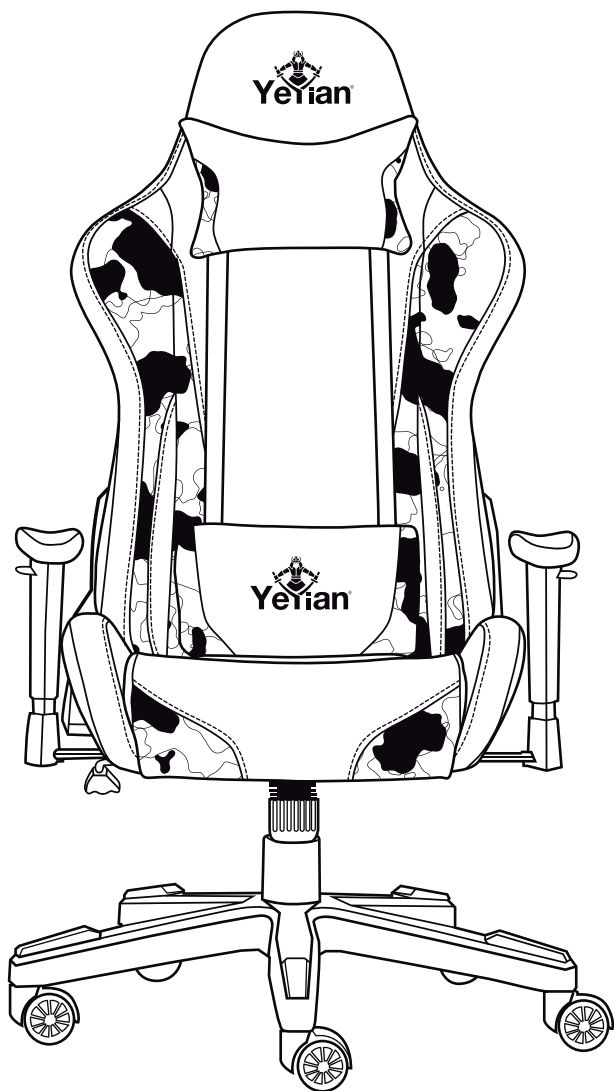

### SPECIFICATIONS / ESPECIFICACIONES

<b>Product Size</b> Tamaño del Producto	<b>32.68 in * 25.60 in * 12.60 in (Packaging Size)</b> <b>53.15 in * 21.26 in * 26.57 in (Chair Size)</b> 830 mm * 650 mm * 320 mm (Tamaño de Embalaje) 1350 mm * 540 mm * 675 mm (Tamaño de Silla)
<b>Product Material</b> Material del Producto	<b>Polyurethane, 1.5 mm Metal Frame, Nylon</b> Poliuretano, Armazón Metálico de 1.5 mm, Nylon
<b>Additional</b> Adicionales	<b>Armrest / Lumbar Cushion / Cervical Cushion</b> Descansabrazos / Cojín Lumbar / Cojín Cervical
<b>Design</b> Diseño	<b>Ergonomic</b> Ergonómico
<b>Mechanism</b> Mecanismo	<b>Butterfly</b> Mariposa
<b>Piston</b> Piston	<b>Class 4 Gas</b> Gas Clase 4
<b>Weight Capacity</b> Capacidad de Peso	<b>Supports up to 330 lbs</b> Soporta hasta 150 kg
<b>Weight</b> Peso	<b>48.8 lbs</b> 19 kg

# PIECES

PIEZAS



**A**  
1 PIECE  
1 PIEZA



**B**  
1 PIECE  
1 PIEZA

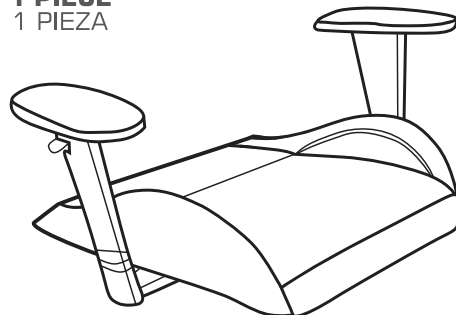

**C**  
1 PIECE  
1 PIEZA

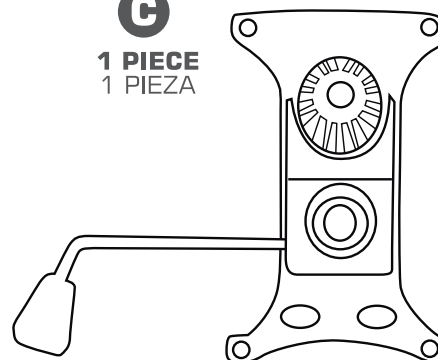

**D**  
1 PIECE  
1 PIEZA



**E**  
1 PIECE  
1 PIEZA

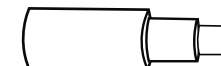

**F**  
1 PIECE  
1 PIEZA

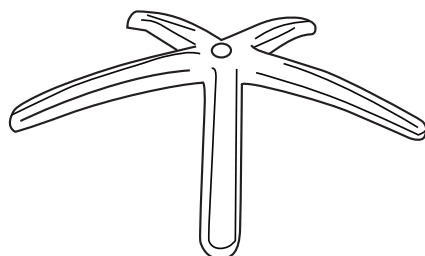

**G**  
5 PIECES  
5 PIEZAS

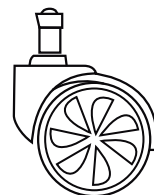

**H**  
10 PIECES  
10 PIEZAS



**To Screw the Mechanical Base  
of the Seat to the Chair**  
Para Atornillar la Base Mecánica  
del Asiento a la Silla

**I**  
4 PIECES  
4 PIEZAS



**J**  
2 PIECES  
2 PIEZAS

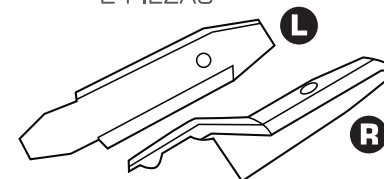

**K**  
2 PIECES  
2 PIEZAS

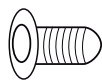

M5x8mm

**L**  
1 PIECE  
1 PIEZA



**M**  
4 PIECES  
4 PIEZAS



**N**  
1 PIECE  
1 PIEZA



**O**  
1 PIECE  
1 PIEZA

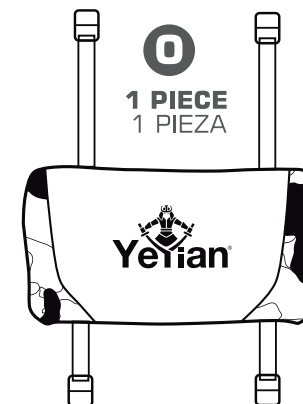

# INSTALLATION

## INSTALACIÓN

