

NZXT

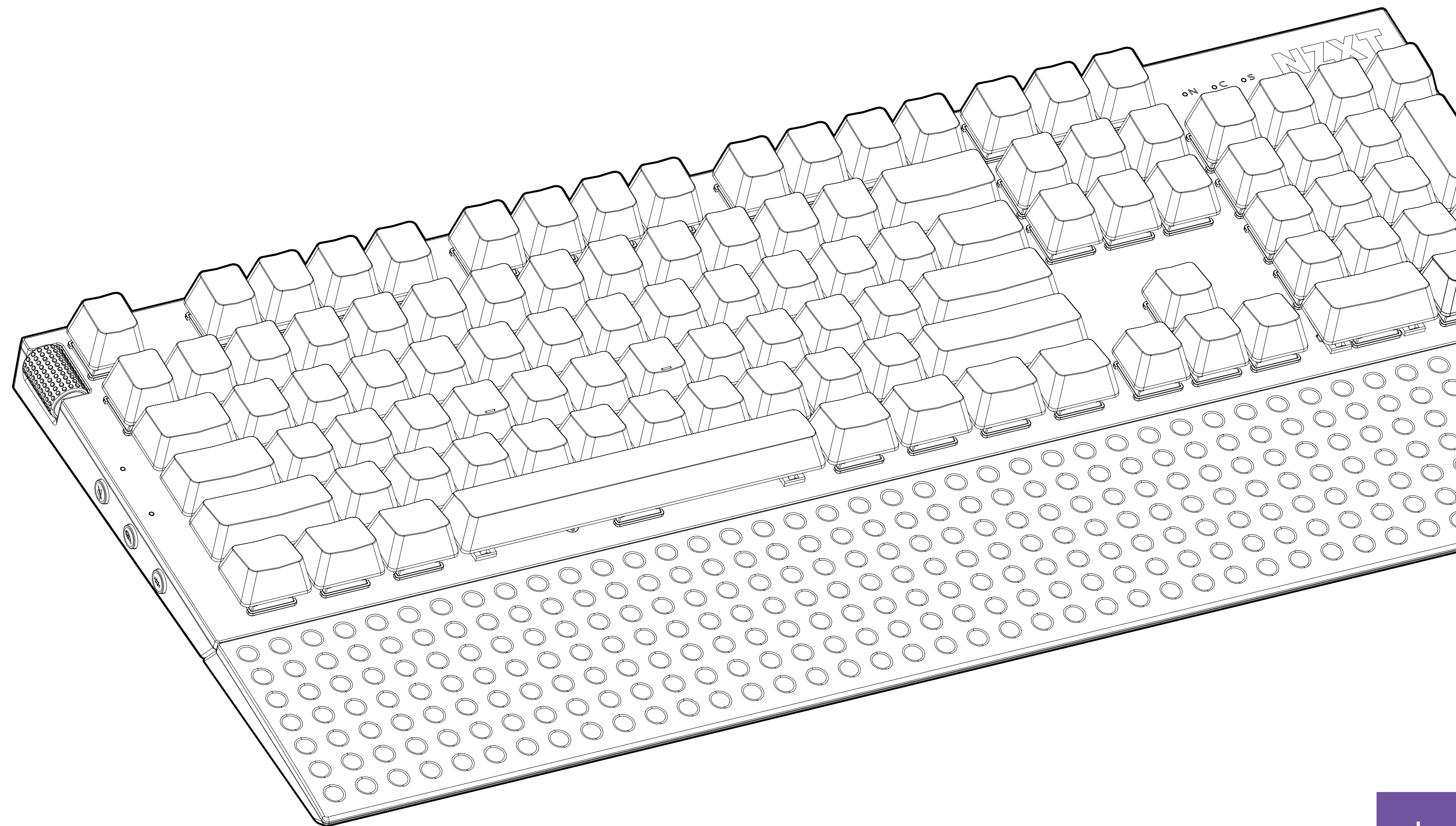

FUNCTION

TECLADO MECÁNICO MODULAR

ESPAÑOL

1. INTRODUCCIÓN 02

2. INFORMACIÓN SOBRE EL
TECLADO FUNCTION KEYBOARD 03

3. CONTENIDO DEL PAQUETE Y
DESCRIPCIÓN 04

4. TECLADO NZXT FUNCTION
KEYBOARD 06

5. CONFIGURACIÓN DEL TECLADO 09

6. CAMBIO DE TAPAS E
INTERRUPTORES DE TECLAS 10

USO DEL TECLADO NZXT
7. FUNCTION KEYBOARD CON EL 14
SOFTWARE CAM

8. USO DEL TECLADO EN
MODO DE HARDWARE 15

9. APÉNDICE A-1

1. INTRODUCCIÓN



¡Enhorabuena, ya tienes tu teclado NZXT Function Keyboard! Tanto si te dedicas profesionalmente al streaming como si juegas solo por diversión, te damos la bienvenida como usuario de dispositivos periféricos de NZXT.

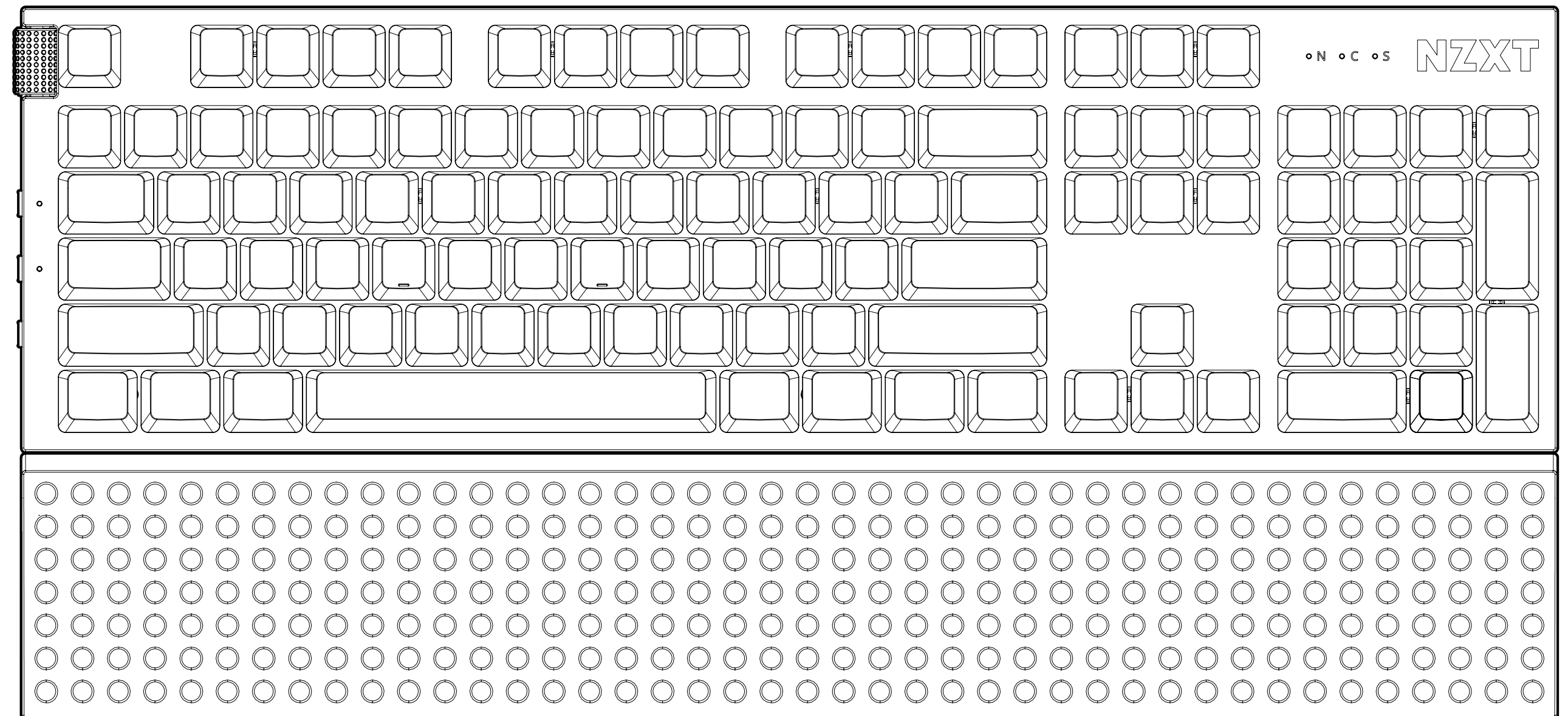

2. INFORMACIÓN SOBRE EL TECLADO FUNCTION KEYBOARD

FUNCTION



El teclado Function Keyboard está diseñado para ser el componente clave de cualquier ordenador para jugar. Los interruptores que hay bajo las teclas mecánicas, que se pueden cambiar de posición sin tener que apagar el sistema, y el diseño de la fila inferior, 100 % estándar, permiten que se pueda personalizar y adaptar por completo.

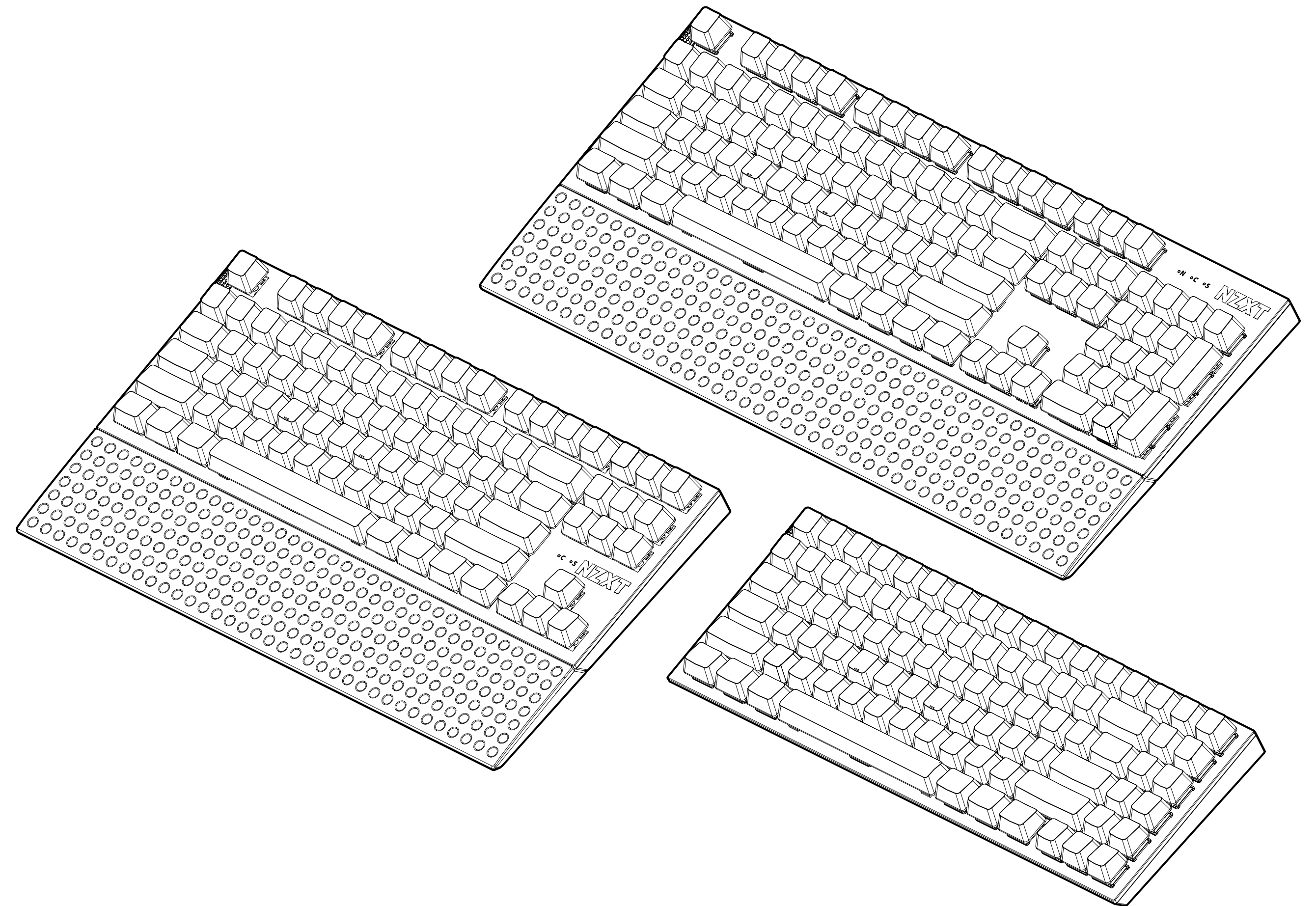

3. CONTENIDO DEL PAQUETE Y DESCRIPCIÓN

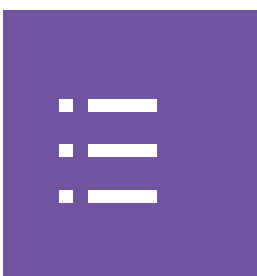

A. Teclado

x1

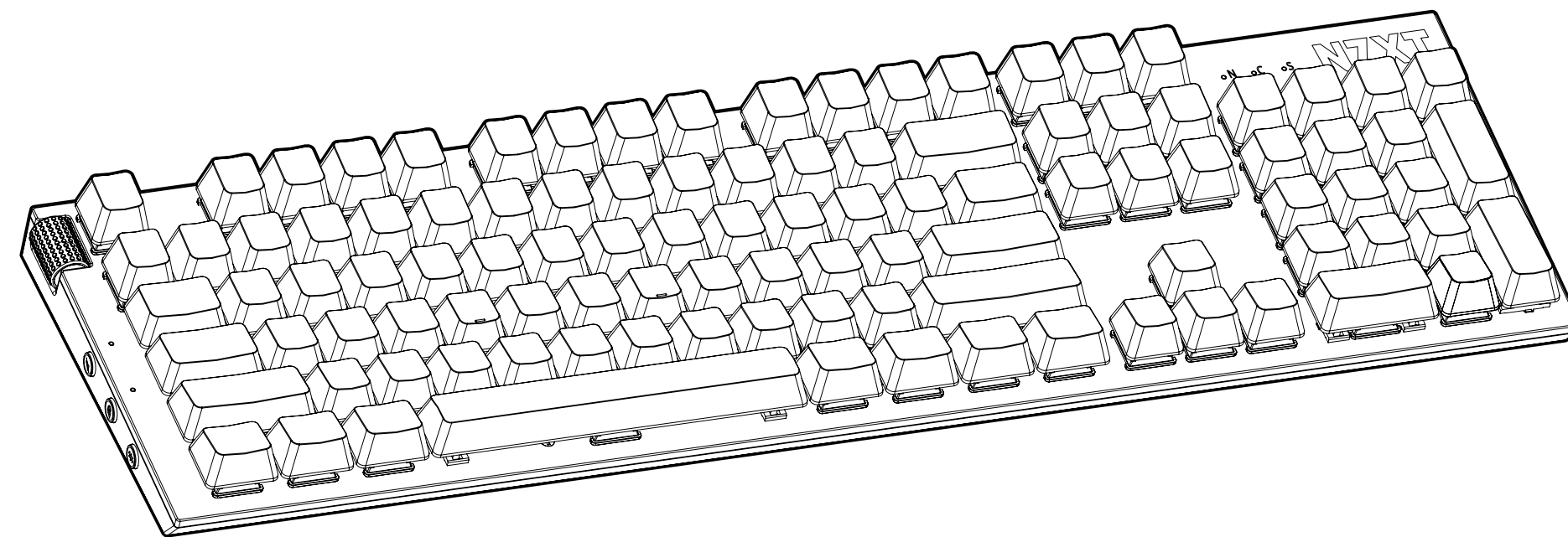

B. Cable USB

x1

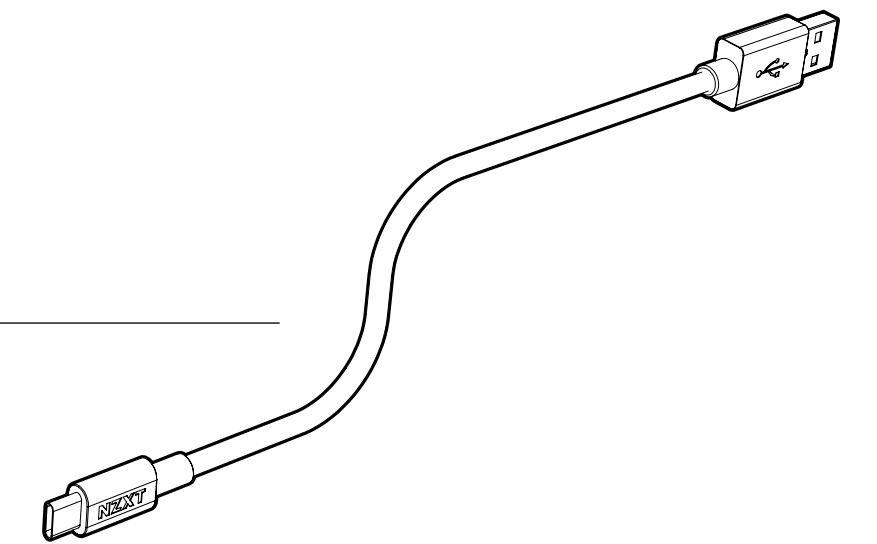

C. Reposamuñecas

(solo en las versiones de tamaño completo y sin teclado numérico)

x1

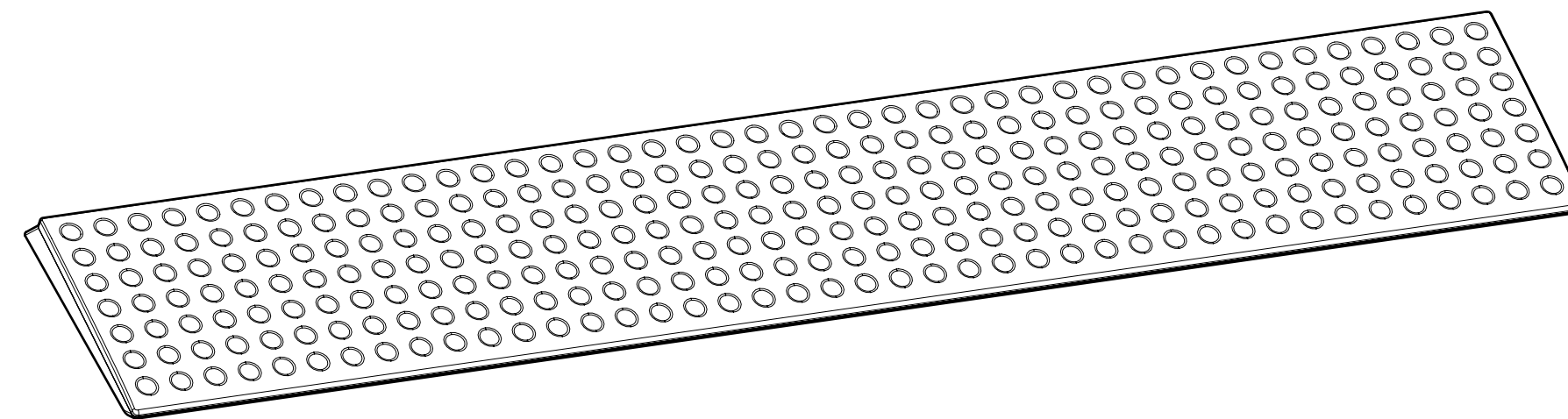

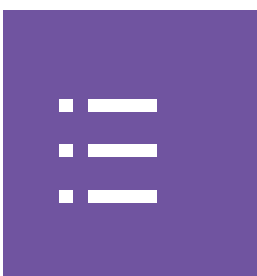

D. Herramienta para extraer tapas de teclas

x1

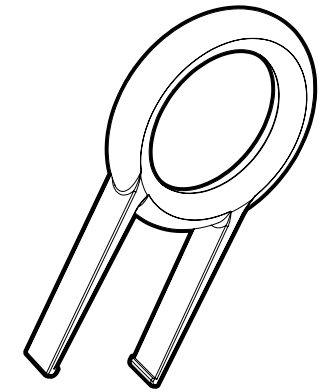

E. Herramienta para extraer interruptores de teclas

x1

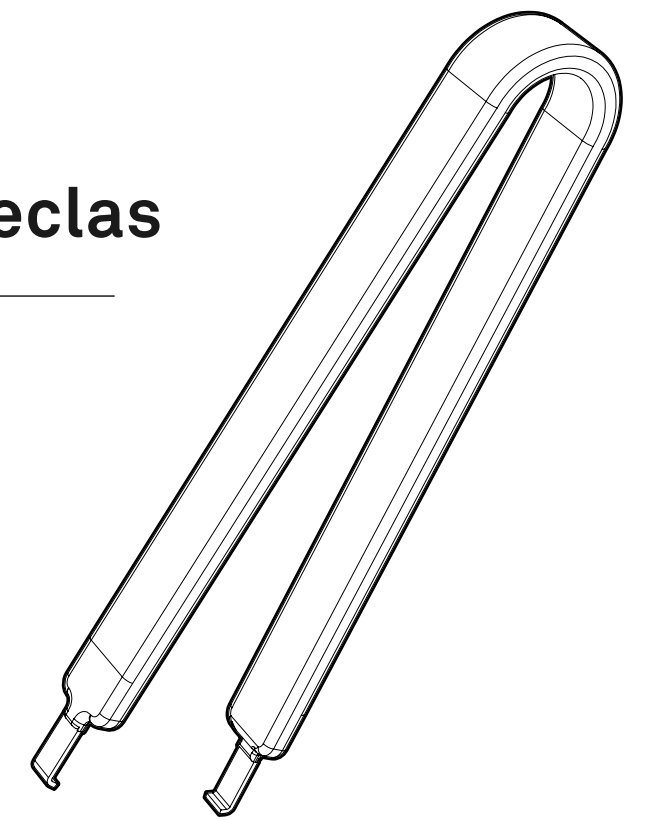

4. TECLADO NZXT FUNCTION KEYBOARD

FUNCTION

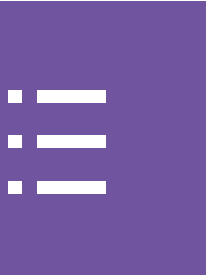

- 1 . Rueda de volumen
- 2 . Botón de silenciar/ensordecer altavoz
- 3 . Botón de bloqueo de la tecla Windows
- 4 . Botón de brillo

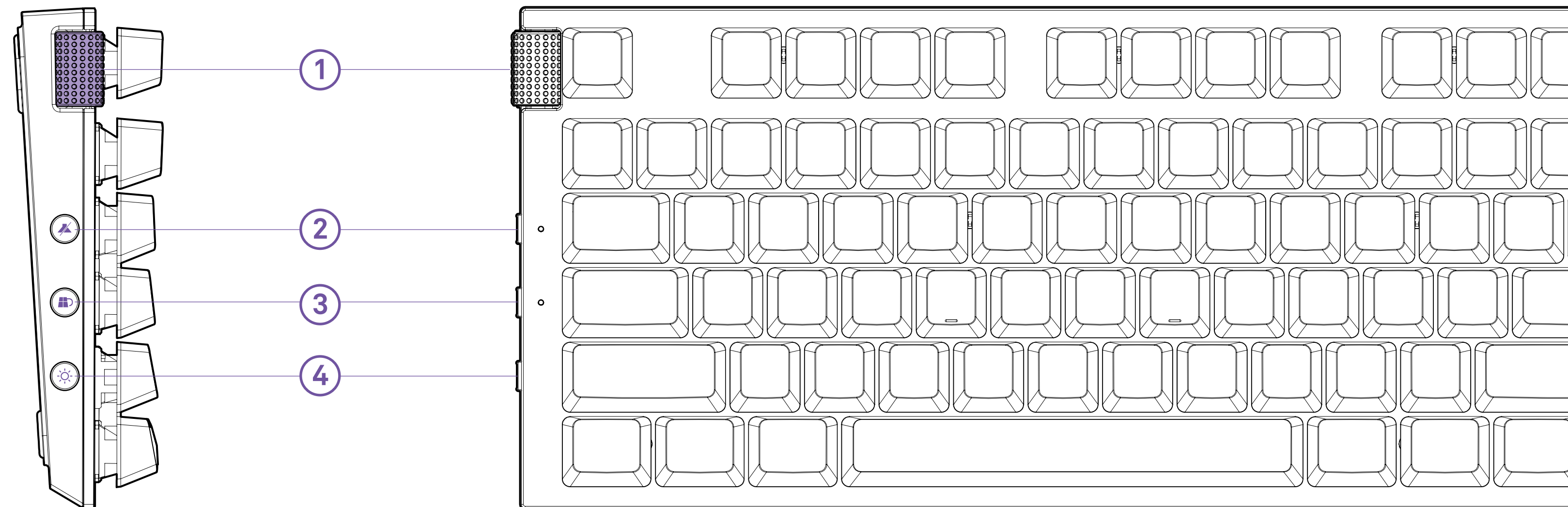

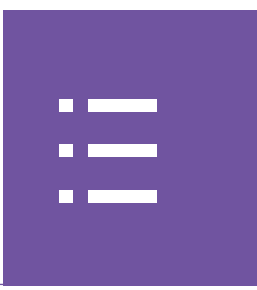

- 5 . Perfil 1 (FN + F1 Key)
- 6 . Perfil 2 (FN + F2 Key)
- 7 . Perfil 3 (FN + F3 Key)
- 8 . Perfil 4 (FN + F4 Key)
- 9 . Indicador de bloqueo numérico
- 10 . Indicador de bloqueo de mayúsculas
- 11 . Indicador de bloqueo de desplazamiento

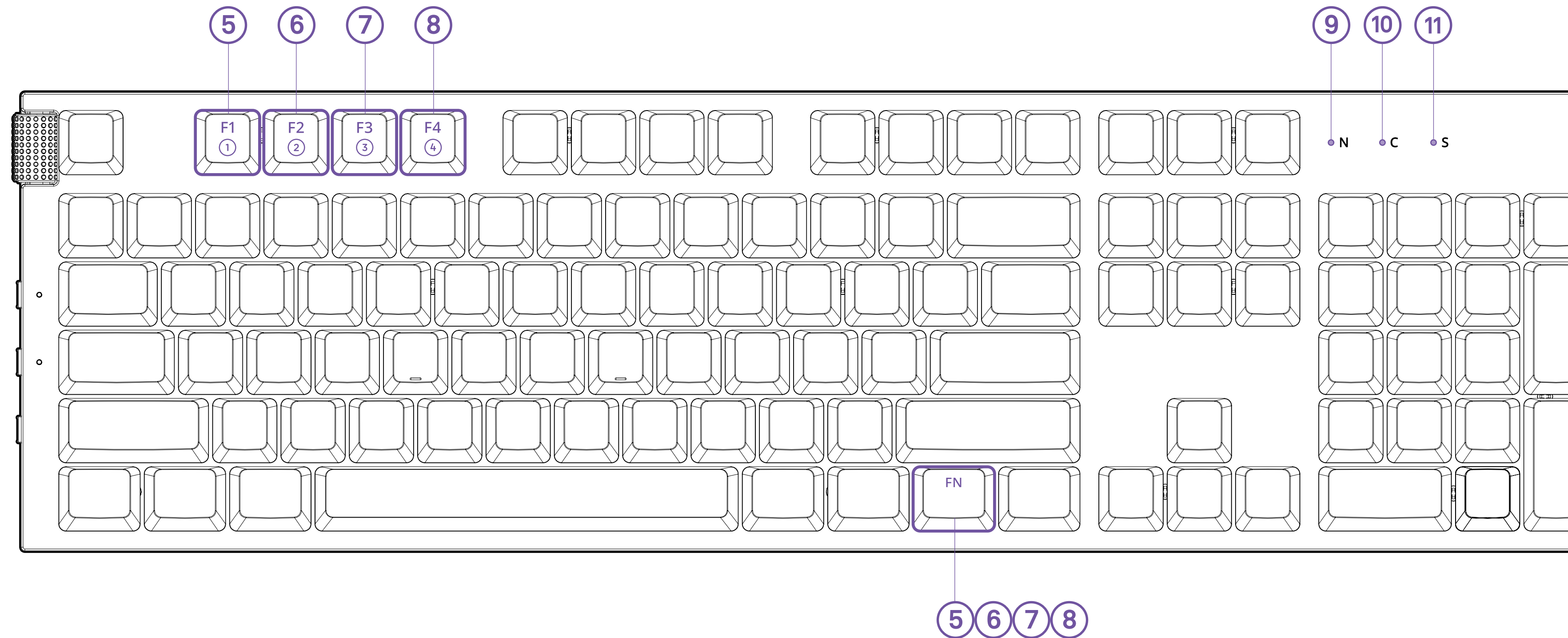



12. Reposamuñecas

13. Puerto USB-C

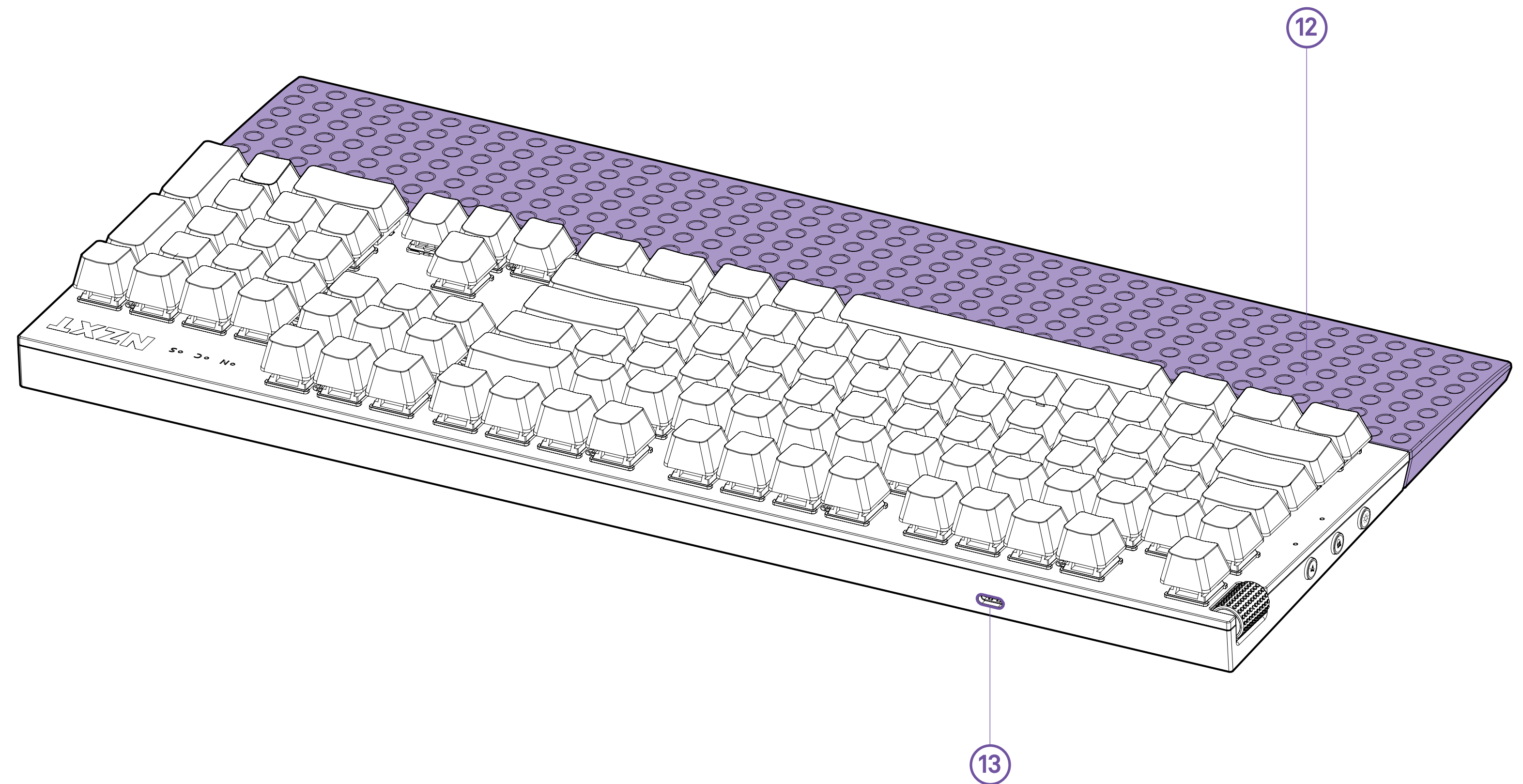

5. CONFIGURACIÓN DEL TECLADO



- a. Conecta el cable USB-C al puerto situado en la parte trasera del teclado, y el otro extremo, a cualquier puerto USB 2.0 (o más rápido) que esté disponible en tu ordenador.

- b. Fija el reposamuñecas (solo en las versiones de tamaño completo y sin teclado numérico) a la parte delantera del teclado. El reposamuñecas es magnético: se acopla y se centra automáticamente.

- c. Si quieres que el teclado esté más inclinado, despliega las patas que hay en la parte inferior trasera. Hay dos patas plegadas, para elegir entre un grado de inclinación máximo o intermedio.



6.1 Extracción/reinstalación de tapas de teclas 11

6.2 Extracción/reinstalación de interruptores de teclas... 12

6.1 EXTRACCIÓN/REINSTALACIÓN DE TAPAS DE TECLAS

FUNCTION



Utiliza la herramienta incluida para tirar de las tapas de las teclas: fíjala a la parte superior de la tecla y tira suavemente para extraer la tapa. Si, al sacar la tapa de la tecla, sale también el interruptor que hay debajo, sigue las instrucciones incluidas a continuación para volver a instalarlo.

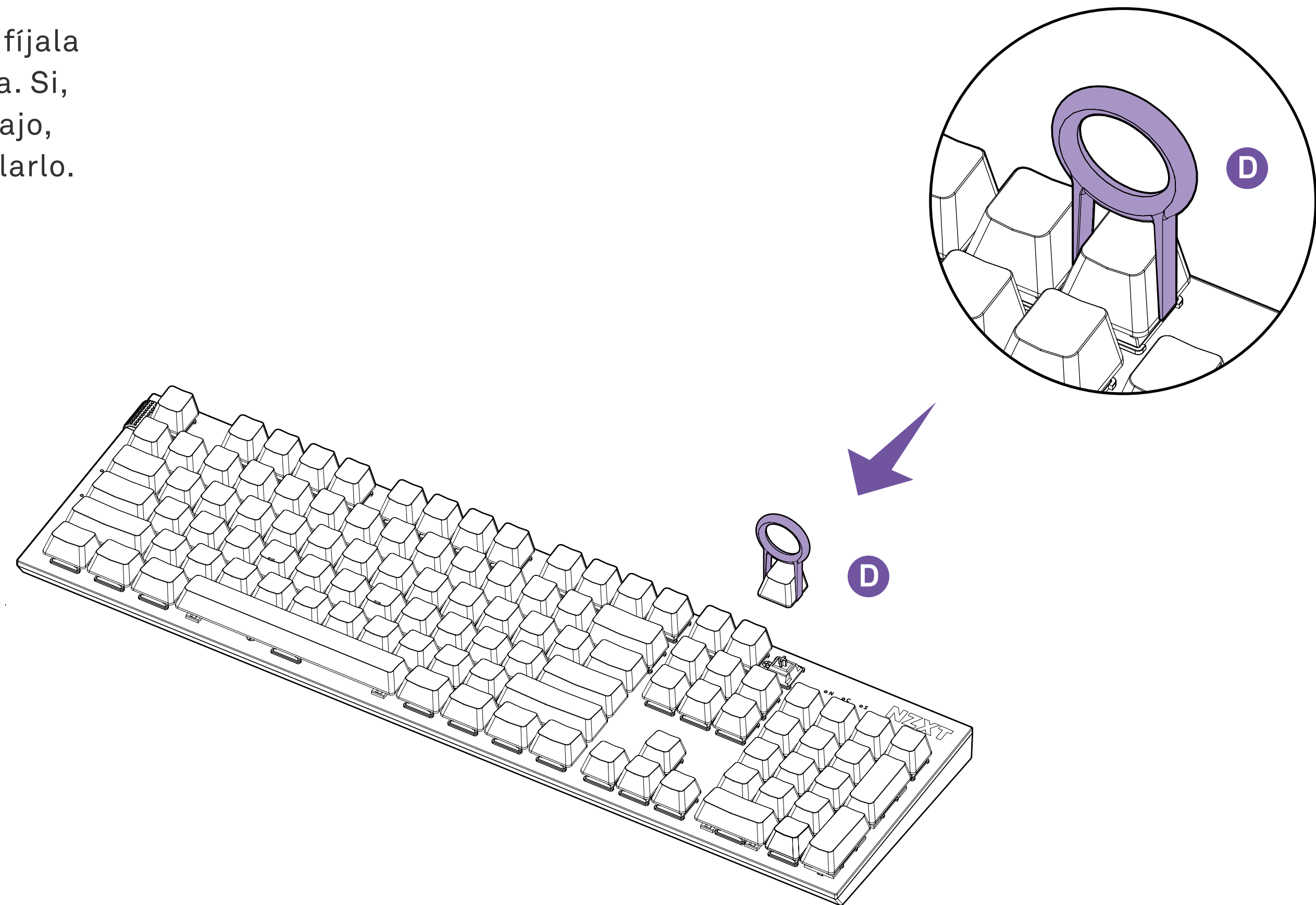

6.2 EXTRACCIÓN/REINSTALACIÓN DE INTERRUPTORES DE TECLAS

FUNCTION



Con la herramienta incluida para extraer interruptores de teclas, agarra el interruptor de la tecla por la parte superior, orientando los extremos de la herramienta a lo largo de las partes trasera y delantera del interruptor. Hay dos lengüetas que sujetan el interruptor a la superficie del teclado y, al presionarlas, permiten extraerlo. Ten en cuenta que la herramienta no debe arañar la superficie del teclado, y no es necesario agarrar el mecanismo por debajo del interruptor. Agarra solamente los laterales de la cajita de plástico, por la parte cercana a la cara inferior.

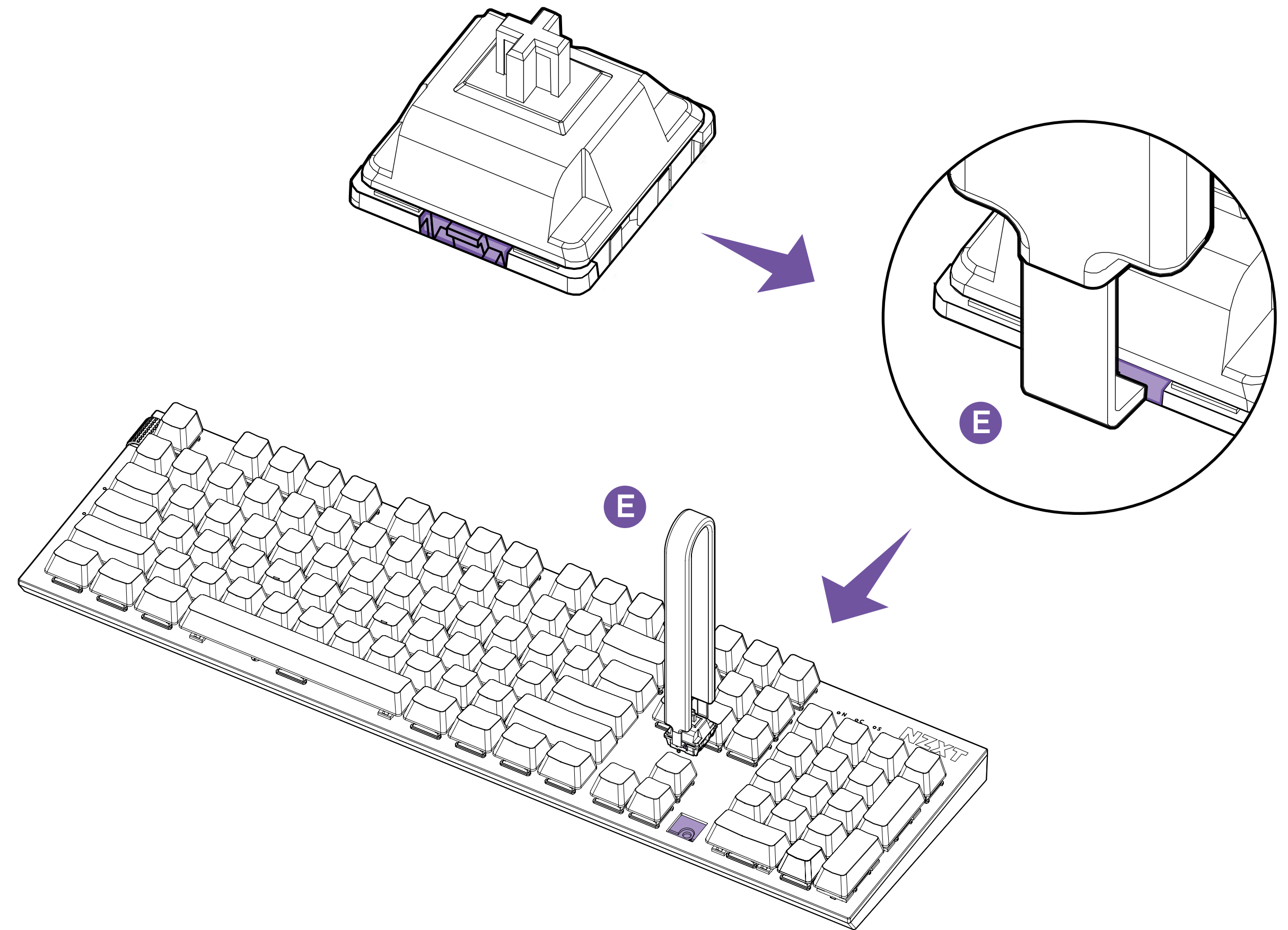



Para volver a instalar en el teclado los interruptores de las teclas, en primer lugar, asegúrate de que todas las clavijas estén rectas, no torcidas ni plegadas hacia la cara inferior de la cajita del interruptor. Comprueba que las dos puntas metálicas que hay en el interruptor se correspondan con los dos huecos situados en el lugar del teclado donde debe encajar el interruptor. Inserta el interruptor con firmeza en su posición del teclado, presionándolo directamente desde arriba. Si está bien insertado, los laterales de la cajita del interruptor deben estar en contacto con la superficie del teclado.

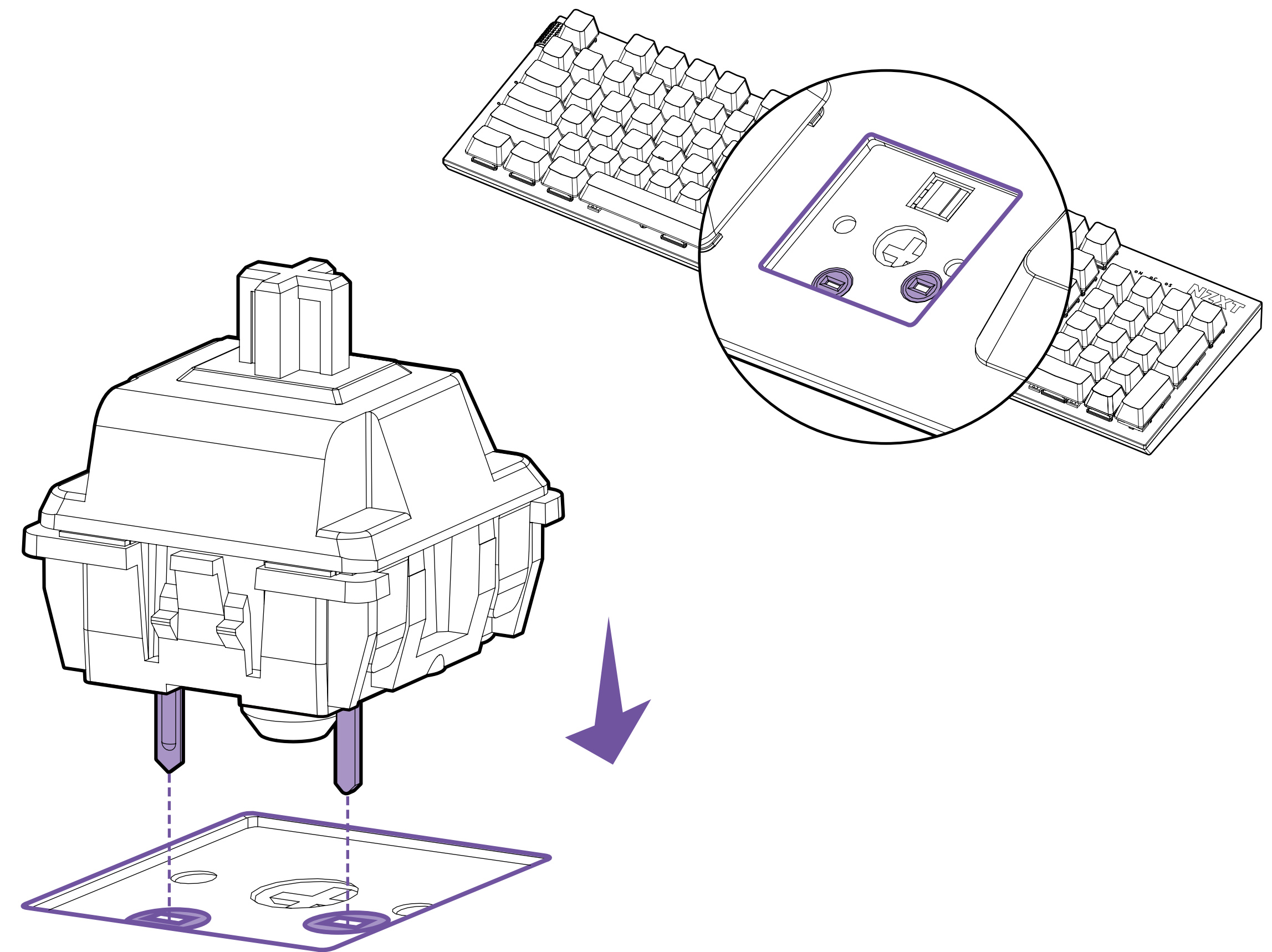

7. USO DEL TECLADO NZXT FUNCTION KEYBOARD CON EL SOFTWARE CAM

FUNCTION



A. DESCARGA E INSTALACIÓN DEL SOFTWARE CAM

Ve a nzxt.com/software/cam para descargar la versión más reciente de CAM.

B. CONFIGURACIÓN DE PERFILES DE CAM Y ALMACENAMIENTO EN EL TECLADO

El teclado Function Keyboard tiene incorporados cuatro perfiles que se pueden configurar y guardar mediante el software CAM. Una vez almacenada la información de los perfiles, no es necesario volver a abrir CAM para accionar la iluminación, las macros, etc., que se hayan guardado.

C. CONTROL DE LOS CAMBIOS DE PERFIL

Al pulsar la tecla FN (abreviatura de «Función») + la tecla F1, F2, F3 o F4, se cambiará al perfil guardado con ese número (del 1 al 4, respectivamente).

D. MODOS DE ILUMINACIÓN

Hay cuatro modos de iluminación predeterminados, guardados en los perfiles del 1 al 4, y se puede acceder a ellos pulsando las teclas FN + F1, F2, F3 o F4.

E. PERSONALIZACIÓN DE LA ILUMINACIÓN RGB

Utilizando CAM/teclado/iluminación, los usuarios pueden personalizar la iluminación tecla a tecla, y configurar perfiles de iluminación (si lo desean), como se explica en el **APARTADO B**.

F. PERSONALIZACIÓN DE MACROS DEL TECLADO

Utilizando CAM/teclado/macros, los usuarios pueden crear macros sencillas o complejas, y guardarlas en perfiles (si lo desean), como se explica en el **APARTADO B**.

G. CAMBIO DE LAS ASIGNACIONES DE TECLAS

Utilizando CAM/teclado/reasignación de teclas, los usuarios pueden crear vinculaciones de teclas nuevas y personalizadas, y guardarlas en perfiles (si lo desean), como se explica en el **APARTADO B**.



A. CONTROL DE LA ILUMINACIÓN RGB

Hay cuatro modos de iluminación predeterminados, guardados en los perfiles del 1 al 4, y se puede acceder a ellos pulsando las teclas FN + F1, F2, F3 o F4. Si se ha configurado alguna iluminación personalizada, y se ha asignado a uno de los perfiles incorporados, al cambiar a un perfil personalizado, se activará esa iluminación personalizada.

B. CAMBIO A PERFILES GUARDADOS (1-4)

Al pulsar la tecla FN (abreviatura de «Función») + la tecla F1, F2, F3 o F4, se cambiará al perfil guardado con ese número (del 1 al 4, respectivamente).

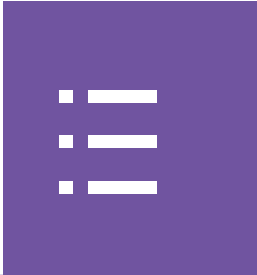

9.1 SUPPORTA-2

9.3 Support and ServiceA-9

9.2 NZXT Global Warranty PolicyA-3

9.4 Regulatory NoticesA-12



Si tienes algún problema y necesitas ayuda para resolverlo, contacta con nosotros por correo electrónico, escribiéndonos a support@nzxt.com

9.2 POLÍTICA DE GARANTÍA GLOBAL DE NZXT

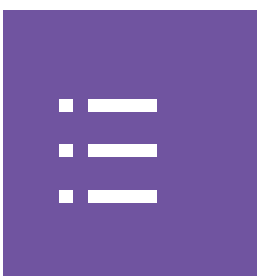

This NZXT Global Warranty Policy governs the sale of products by NZXT to you.

I. WARRANTY LENGTH

Any replacement product will be covered under warranty for the remainder of the warranty period or thirty days, whichever is longer. Proof of purchase is required for warranty service.

II. WHO IS PROTECTED

The Warranty covers only NZXT products purchased by the original consumer.

NEW NZXT PRODUCT	WARRANTY LENGTH FOR PARTS
Computer Cases	2 Years
Temperature Meters	2 Years
Fans	2 Years
Lighting	2 Years
Accessories	2 Years
Kraken M Coolers	3 Years
NZXT Keyboard	2 Years
Headset/Headphone Storage	2 Years
USB Microphone	2 Years
Motherboards	3 Years
Gold Power Supply	10 Years
Kraken X/X RGB/Z Coolers	6 Years
Mini ITX Case with PSU, AIO, and Riser Card	3-year warranty on case, riser card, and AIO. 10-year warranty on PSU.
REFURBISHED NZXT PRODUCT	WARRANTY LENGTH FOR PARTS
All NZXT Certified Refurbished Products	1 Years



III. WHAT IS AND IS NOT COVERED

Please note that our warranty is not an unconditional guarantee. If the product, in NZXT's reasonable opinion, malfunctions within the warranty period, NZXT will provide you at its sole discretion with a repaired or replacement product, either new or refurbished, with a similar function that is equal or greater in value depending on supply.

Our warranty does not cover the following:

- any product or serial number/warranty sticker modification applied without permission from NZXT;
- any damage that is not a manufacturing defect;
- damage, deterioration or malfunction resulting from: accident, abuse, misuse, neglect, fire, water, lightning, or other acts of nature, unauthorized product modification or failure to follow instructions included with the product;
- improper installation, unauthorized alterations or modifications, or repair or attempted repair by anyone not authorized by NZXT;
- shipping or transport damage (claims must be made with the carrier);
- normal wear and tear.

NZXT does not warrant that this product will meet your requirements. It is your responsibility to determine the suitability of this product for your purpose. For NZXT Store orders, we cover two way return shipping for all exchanges and returns. For all other authorized dealers, NZXT Support does not cover return shipping and only covers one way shipping from NZXT back to the end user for exchanges. Two way expedited shipping is provided for all PSUs covered under the Less Than Three program, indiscriminate of purchase location, provided the location is an approved NZXT reseller.

IV. EXCLUSION OF DAMAGES (DISCLAIMER)

NZXT's sole obligation and liability under this warranty is limited to the repair or replacement of a defective product with either a new or refurbished product with a similar function that is equal or greater in value at our option. NZXT shall not, in any event, be liable for any incidental or consequential damage, including but not limited to damages resulting from interruption of service and loss of data, business, or for liability in tort relating to this product or resulting from its use or possession.



V. LIMITATIONS OF IMPLIED WARRANTIES

Here are no other warranties, expressed or implied, including but not limited to those of merchantability or fitness for a particular purpose. The duration of implied warranties is limited to the warranty length specified in Paragraph I.

VI. TO OBTAIN TECHNICAL SUPPORT

If you have already referenced your product owner's manual and still need help, you may contact us by phone at +1 (800) 228-9395, by email at service@nzxt.com, or visit the NZXT Support site at nzxt.com/customer-support.

VII. HOW TO OBTAIN A WARRANTY SERVICE FROM NZXT

To receive a warranty service for your product when purchased directly from NZXT, you must submit a request via the NZXT Support site outlining the problem. If a technician deems the product defective or requiring testing, you will be required to provide a copy of your proof of purchase, which will enable you to submit a Return Merchandise Authorization "RMA" request.

Once approved, you'll receive an RMA number, upon which you will be asked to ship the defective item back to NZXT with the RMA number clearly marked or labelled on the package. NZXT recommends that appropriate measures are taken to safeguard the product from damage during shipping.



VIII. APPLICABLE LAW AND ADDITIONAL LEGAL RIGHTS FOR CONSUMERS

This warranty gives you specific legal rights. These conditions are governed and construed in accordance with the laws of California (with exception of its conflict of law provisions), and the application of the United Nations Convention of Contracts for the International Sale of Goods is expressly excluded. The non-exclusive jurisdiction of the courts of California is agreed, which means that you may bring a claim to enforce your consumer protection rights in connection with this Global Warranty in the country which you have your habitual residence where you may have additional rights. These rights may vary.

For original consumers who are covered by consumer protection laws or regulations in their country, state, or province of purchase or, if different, their country, state, or province of residence, the benefits conferred by this warranty are in addition to all rights and remedies conveyed by such consumer protection laws and regulations. To the extent that liability under such consumer laws can be limited, NZXT's liability is limited, and its sole option, to repair or replacement, either new or refurbished, with a similar function that is equal or greater in value depending on supply.

In the United Kingdom:

- For NZXT products sold to customers in the UK, during the expected lifespan of your product your legal rights entitle you to the following:
 - › Up to 30 days: if your goods are faulty, then you can get an immediate refund.
 - › Up to six months: if your goods can't be repaired or replaced, then you're entitled to a full refund, in most cases.
 - › Up to six years: if your goods do not last a reasonable length of time you may be entitled to some money back.
- If the person seeking to rely on the guarantee is not the original consumer, the NZXT Warranty will cover the product in relation to that person provided that they are able to provide proof of the transfer of the benefit of the guarantee from the original consumer.
- The implied warranties under the Consumer Rights Act 2015 says that your goods must be as described, fit for all purposes for which such goods are usually supplied, and of satisfactory quality.

In the EU:

- If you are a consumer and have your habitual residence in the EU, you additionally enjoy the protection afforded to you by provisions that cannot be derogated from by agreement by virtue of the law where you have your habitual residence.



IX. WARRANTY SERVICE FROM RESELLERS

In the event that a warranty service is sought, you must provide proof of purchase (store receipt or invoice) in order to receive the service and if deemed necessary, repair or replacement product.

In North America:

Within the first 60 days after purchase, please return your product (or for power supplies installed within our enclosures, just the failed power supply) to your dealer or reseller for a replacement. If the product is still within warranty and you can no longer return it to your dealer, please contact NZXT Customer Support (see above) for assistance and instructions. NZXT will not accept returns without prior approval and an RMA number.

In Europe:

Within the first year after purchase, please return your product (or for power supplies installed within our enclosures, just the failed power supply) to your dealer or reseller for a replacement. If the product is still within warranty and you can no longer return it to your dealer, please contact NZXT Customer Support (see above) for assistance and instructions. NZXT will not accept returns without prior approval.

In Australasia:

Within the first two years after purchase, please return your product (or for power supplies installed within our enclosures, just the failed power supply) to your dealer or reseller for a replacement. If the product is still within warranty and you can no longer return it to your dealer, please contact NZXT Customer Support (see above) for assistance and instructions. NZXT will not accept returns without prior approval.

The cost of shipping will be borne at the first instance by you; however, if the purchased item is defective, NZXT will reimburse reasonable postage or transportation of costs.

Outside North America, Europe, and Australasia:

If your product needs to be returned within the warranty period, please contact the retailer or distributor from whom you purchased the product.

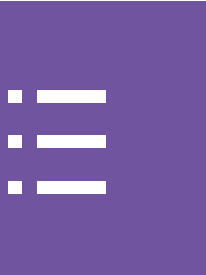

X. NZXT.COM STORE RETURNS/EXCHANGE POLICY

Eligible products under this NZXT Warranty qualify for a full refund or exchange only with an authorized RMA number and if the item is returned to the NZXT.com store inventory within 30 days of purchase. Returns are not allowed beyond 30 days of the purchase date. The NZXT.com Store reserves the right to deny any return or exchange. Refunds will be credited to the original method of payment. To initiate a return, simply submit a request via NZXT support site.

- > Visit nzxt.com/warranty and support.nzxt.com for information on warranty coverage and service.
- > Visite el sitio Web nzxt.com/warranty y support.nzxt.com para obtener información sobre la cobertura y el servicio de la garantía.
- > Visitez nzxt.com/warranty et support.nzxt.com pour les informations de la couverture de la garantie et du service.
- > Informationen zu Geltungsbereich und Service der Garantie finden Sie unter support.nzxt.com und nzxt.com/warranty.
- > Visitare il sito nzxt.com/warranty e support.nzxt.com per informazioni sulla copertura e sul servizio della garanzia.
- > Visite nzxt.com/warranty e support.nzxt.com para obter informações sobre a cobertura da garantia e assistência.
- > Подробную информацию об условиях гарантийного обслуживания см. на веб-сайте nzxt.com/warranty и support.nzxt.com.
- > 제품 보증 범위와 서비스 정보를 확인하시려면 nzxt.com/warranty 또는 support.nzxt.com 을 방문해 주시기 바랍니다.
- > 保証範囲およびサービスに関する情報については、support.nzxt.com と nzxt.com/warranty にアクセスしてください。
- > 请造访 nzxt.com/warranty 和 support.nzxt.com 了解保修范围和服务的信息。
- > 請訪問 nzxt.com/warranty 和 support.nzxt.com 了解產品保固範圍和更多服務訊息。

NZXT, Inc./ 15736 E. Valley Blvd, City of Industry, CA 91744, USA
NZXT Europe GmbH/ Industriering Ost 66 | 47906 Kempen | Germany
+1 (800) 228-9395 / service@nzxt.com / support@nzxt.com / [NZXT.com](https://nzxt.com)



SUPPORT AND SERVICE

If you have any questions or problems with the NZXT product you purchased, please don't hesitate to contact us using our support system.

nzxt.com/customer-support

Please include a detailed explanation of your problem and your proof of purchase. For comments and suggestions, you can e-mail our design team, designer@nzxt.com. Lastly we would like to thank you for your support by purchasing this product.

For more information about NZXT, please visit us online. NZXT Website: [NZXT.com](https://nzxt.com)

SOPORTE Y SERVICIO

Si tiene preguntas o problemas con el producto NZXT que usted compró, no dude en ponerse en contacto con service@nzxt.com y suministrar una explicación detallada de su problema así como su prueba de compra.

Puede hacer consultas sobre piezas de repuesto en nzxt.com/customer-support. Para comentarios y sugerencias, escriba un mensaje de correo electrónico a nuestro equipo de diseño: designer@nzxt.com. Gracias por comprar un producto NZXT. Para más información acerca de NZXT, visítenos en línea. Página web de NZXT: [NZXT.com](https://nzxt.com)

SUPPORT ET SERVICE

Si vous avez des questions ou des problèmes avec le produit NZXT que vous avez acheté, n'hésitez pas à contacter service@nzxt.com avec une description détaillée de votre problème et votre preuve d'achat. Vous pouvez aussi commander des pièces de remplacement auprès nzxt.com/customer-support. Pour les commentaires et les suggestions, envoyez un email à notre équipe de design, designer@nzxt.com. Merci d'avoir acheté ce produit de NZXT. Pour plus d'informations sur NZXT, visitez notre site Web. Site Web de NZXT : [NZXT.com](https://nzxt.com)

KUNDENDIENST UND SERVICE

Falls Fragen oder Probleme bezüglich Ihres NZXT-Produktes auftreten, wenden Sie sich bitte mit einer detaillierten Problembeschreibung und Ihrem Kaufbeleg an service@nzxt.com. Ersatzteile können Sie unter nzxt.com/customer-support anfragen. Kommentare und Anregungen senden Sie bitte per designer@nzxt.com an unser Designteam. Vielen Dank, dass Sie ein NZXT-Produkt erworben haben. Weitere Informationen über NZXT erhalten Sie im Internet. NZXT-Webseite: [NZXT.com](https://nzxt.com)



ASSISTENZA E SERVIZIO

In caso di dubbi o problemi con il prodotto NZXT acquistato, non esitate a contattarci utilizzando il nostro sistema di assistenza.

nzxt.com/customer-support

Includere una spiegazione dettagliata del problema e la prova di acquisto. Per commenti e suggerimenti, siete pregati di inviare un messaggio al nostro team di progettisti, all'indirizzo: designer@nzxt.com. Infine, vogliamo ringraziarvi del vostro supporto con l'acquisto di questo prodotto. Per altre informazioni su NZXT, visitate il nostro sito. Sito NZXT: [NZXT.com](https://nzxt.com)

ASSISTÊNCIA E MANUTENÇÃO

Caso tenha questões ou problemas com o produto NZXT adquirido, não hesite em contactar-nos através do endereço service@nzxt.com fornecendo a explicação detalhada do seu problema e a prova de compra. Poderá solicitar peças de substituição através do endereço nzxt.com/customer-support. Para comentários e sugestões, contacte a nossa equipa de design através do endereço de e-mail, designer@nzxt.com. Obrigado por ter adquirido um produto NZXT. Para mais informações acerca da NZXT, visite-nos online. Web site da NZXT: [NZXT.com](https://nzxt.com)

СЛУЖБА ПОДДЕРЖКИ И ОБСЛУЖИВАНИЯ

В случае возникновения вопросов или неисправностей в приобретенных вами продуктах NZXT обращайтесь по адресу: service@nzxt.com с подробным описанием проблемы и подтверждением покупки. О наличии запчастей можно узнать, обратившись по адресу: nzxt.com/customer-support. Замечания и предложения отправляйте в адрес нашей группы разработчиков: designer@nzxt.com. Благодарим вас за покупку продукта NZXT. Более подробная информация о компании NZXT представлена на наших веб-сайтах. Веб-сайт NZXT: [NZXT.com](https://nzxt.com)



지원 및 서비스

구입한 NZXT 제품과 관련하여 질문 또는 문제가 있을 경우, 당사의 지원 시스템 (nzxt.com/customer-support)을 사용하여 문의하십시오.

문제를 자세히 기술하고 구매 증빙을 제출하십시오. 의견 또는 제안 사항이 있을 경우 당사 설계 팀에 designer@nzxt.com으로 이메일을 보내십시오. 마지막으로 이 제품을 구입하여 당사를 응원해 주셔서 감사합니다. NZXT에 대해 자세히 알려면 온라인으로 방문하십시오. NZXT 웹사이트: [NZXT.com](https://nzxt.com)

サポートおよびサービス

購入されましたNZXTの製品に関するご質問または問題は、問題の詳細および購入の証明を添えて、ご遠慮なくservice@nzxt.comまでご連絡ください。交換部品は nzxt.com/customer-supportまでお尋ねください。ご意見およびご提案は弊社設計チーム、designer@nzxt.com までメールを送信してください。NZXT製品をご購入いただきましてありがとうございます。NZXTに関する詳細は、インターネット上のウェブサイトをご覧ください。NZXTウェブサイト: [NZXT.com](https://nzxt.com)

支持和服務

如果有任何疑问或者在使用 NZXT 产品的过程中遇到任何问题,欢迎联络 service@nzxt.com,联络时请提供关于问题的详细说明及购买凭证。您可以向 nzxt.com/customer-support 查询更换部件。如有任何意见或建议,欢迎致信我们的设计团队,电子邮件地址是 designer@nzxt.com。感谢您购买 NZXT 产品。有关 NZXT 的更多信息,请造访我们的在线网站。NZXT 网站: [NZXT.com](https://nzxt.com)

支援和服務

如果在使用NZXT 產品的過程中有遇到任何問題或疑問，歡迎聯繫 service@nzxt.com，並請提供問題的詳細敘述及購買證明。您可以透過 nzxt.com/customer-support 查詢更換部件。如有任何意見或建議，歡迎來信與設計團隊聯繫 designer@nzxt.com。最後，感謝您購買 NZXT 產品。有關 NZXT 的更多信息，請訪問我們的網站。NZXT 網站: [NZXT.com](https://nzxt.com)



This device complies with part 15 of the FCC Rules.

Operation is subject to the following two conditions:

- (1) This device may not cause harmful interference, and
- (2) this device must accept any interference received, including interference that may cause undesired operation.

