

Support

Unterstützung / Soporte / Suporte / Supporto / Техническая поддержка / Wsparcie / Destek / 支援 / 支持 / サポート / 지원

Please visit <http://www.gigabyte.com/support-downloads/customer-service> to find your BRiX warranty information from the drop down list, or by clicking on the map. You will then be directed to the corresponding page for your region.

Veillez visiter la page <http://www.gigabyte.fr/support-downloads/customer-service> afin de trouver toutes les informations concernant la garantie du BRiX. Il suffit de sélectionner le menu déroulant ou de cliquer sur la carte. Vous serez alors redirigé vers la page correspondante à votre région.

Por favor visite <http://www.gigabyte.com/support-downloads/customer-service> para encontrar informações sobre a garantia do BRiX na lista ou clicando no mapa. Será redirecionado para a página correspondente da sua região.

Чтобы найти информацию о гарантийных обязательствах на вашу модель BRiX, пожалуйста, посетите страницу <http://www.gigabyte.com/support-downloads/customer-service.aspx> и укажите страну в выдающем списке. Вы будете перенаправлены на соответствующую страницу вашего регионального сайта.

Asağdaki listede veya harita üzerinden tıklayarak, açılan menüden, BRiX garanti bilgilerini bulmak için <http://www.gigabyte.com/support-downloads/customer-hizmet-ziyaret-ediniz>. Daha sonra bulduğunuz bölge için ilgili sayfaya yönlendirileceksiniz.

<http://www.gigabyte.com/support-downloads/customer-service.aspx> 를 방문하시면 구입하신 BRiX 보장내용을 확인할 수 있습니다. 드롭다운리스트 또는 맵을 클릭하면 거주국가에 해당하는 페이지로 연결됩니다.

● For a list of tested memory, M.2 SSD, 2.5" HDD, wireless adapters and OS supported, go to: <http://www.gigabyte.com>
● To download the latest drivers and BIOS updates, go to: <http://www.gigabyte.com>
● For product support, go to: <http://www.gigabyte.com>

● Eine Liste mit geprüftem Arbeitsspeicher, M.2 SSD, 2.5" HDD, drahtlosen Adaptern und unterstützten Betriebssystemen finden Sie bitte unter: <http://www.gigabyte.com>
● Für den Download aktueller Treiber und BIOS-Updates gehen Sie bitte zu: <http://www.gigabyte.com>
● Unterstützung zu Produkten finden Sie bitte unter: <http://www.gigabyte.com>

● Pour obtenir une liste de mémoire, M.2 SSD, disques 2.5" HDD, adaptateurs sans fil et systèmes d'exploitation compatible, veuillez vous rendre sur : <http://www.gigabyte.fr>
● Télécharger la dernier version de mis à jour du bios et des pilotes, veuillez vous rendre sur: <http://www.gigabit.fr>
● Pour l'assistance produit, veuillez vous rendre sur : <http://www.gigabyte.fr>

● Para obtener una lista de memorias probadas, M.2 SSD, HDD 2.5", adaptadores inalámbricos y sistemas operativos compatibles, visite: <http://es.gigabyte.com>
● Para descargar los últimos controladores y actualizaciones de BIOS, vaya a: <http://es.gigabyte.com>
● Para el soporte del producto, visite: <http://es.gigabyte.com>

● Para a lista de memórias testadas, M.2 SSD, HDD 2.5", adaptadores wireless e Sistemas Operacionais suportados, acesse: <http://br.gigabyte.com>
● Para baixar os drivers mais recentes e atualizações de BIOS, acesse: <http://br.gigabyte.com>
● Para suporte ao produto, acesse: <http://br.gigabyte.com>

● Per una lista di compatibilità di HDD 2,5", M.2 SSD, memorie, adattori Wireless e OS supportati visita: <http://www.gigabyte.com>
● Per scaricare gli ultimi Driver e BIOS visita: <http://www.gigabyte.com>
● Per supporto visita: <http://www.gigabyte.com>

● Подробная информация о протестированных модулях ОЗУ, M.2 SSD, 2.5" HDD и модулях беспроводной связи под управлением совместимой ОС размещена по адресу: <http://www.gigabyte.com>
● Для загрузки актуальных драйверов и обновлений версии BIOS воспользуйтесь ссылкой: <http://www.gigabyte.com>
● Информация о технической поддержке продукта размещена по адресу: <http://www.gigabyte.com>

● Listę kompatybilnych komponentów (pamięć, M.2 SSD, 2.5" HDD, karty rozszerzeń) oraz systemów operacyjnych można znaleźć pod adresem: <http://gigabyte.com>
● Najnowsze wersje sterowników oraz BIOSu można pobrać ze strony:<http://www.gigabyte.com>
● Aby uzyskać wsparcie dotyczące produktów proszę wejść na stronę internetową: <http://www.gigabyte.com>

● Test edilen hafıza listesi için, M.2 SSD, 2.5" HDD, kablusuz adaptörler ve desteklenen OS için, ilgili adrese gidiniz: <http://www.gigabyte.com>
● En son sürücüler ve BIOS güncellemelerini indirmek için, ilgili adrese gidiniz: <http://www.gigabyte.com>
● Ürün desteği için, ilgili adrese gidiniz: <http://www.gigabyte.com>

● 如需已測試記憶體、M.2 SSD、2.5" SATA HDD、無線介面卡和支援的作業系統清單，請前往 <http://www.gigabyte.com>
● 若要下載最新驅動程式和 BIOS 更新，請前往: <http://www.gigabyte.com>
● 如需產品支援資訊，請前往: <http://www.gigabyte.com>

● 如需已測試內存、M.2 SSD、2.5" SATA HDD、無線適配卡和支援的操作系統列表，請前往: <http://www.gigabyte.com>
● 若要下載最新驅動程序和 BIOS 更新，請前往: <http://www.gigabyte.com>
● 如需產品支持信息，請前往: <http://www.gigabyte.com>



● 動作確認済みのメモリ、M.2 SSD、2.5" SATA HDD、ワイヤレスアダプター、OS のリストについては、次のサイトで確認できます: <http://www.gigabyte.com>
● 最新のドライバーおよび BIOS のアップデートをダウンロードの場合、次を参照してください。
● 製品のサポート情報については、次を参照ください。

● 테스트한 메모리, 무선 어댑터 지원 관련 목록은 <http://www.gigabyte.com> 을 참조하십시오
● 최신 드라이버 및 BIOS 의 업데이트는 홈페이지 <http://www.gigabyte.com> 에서 다운로드하십시오.
● 제품 지원에 대한 상세한 내용은 홈페이지 <http://www.gigabyte.com> 를 참조하십시오.

Safety and Regulatory Information

Sicherheitshinweise und Normen / Information sur la Sécurité et Réglementation / Seguridad y Normativa / Informações Regulatórias e de Segurança / Informazioni di Sicurezza e Regolamenti

Меры безопасности и нормативная информация / Bezpieczeństwo i zgodność z przepisami / Güvenlik ve Yasal Bilgiler / 安全規範 / 安全规范 / 安全性と規制に関する情報 / 안전 및 규제 정보

<p>Risk of explosion if the battery is replaced with an incorrect type. Batteries should be recycled where possible. Disposal of used Batteries must be in accordance with local environmental regulations.</p>	<p>Failure to use the included Model GB-BR Power Adapter may violate regulatory compliance and may expose the user to safety hazards.</p>
<p>Es besteht Explosionsgefahr, wenn die Batterie durch einen falschen Typ ersetzt wird. Batterien müssen recycelt werden, sofern möglich. Gebrauchte Batterien müssen gemäß den örtlichen Umweltschutzvorschriften entsorgt werden.</p>	<p>Die Nichtbenutzung des mitgelieferten Netzteils Modell GB-BR könnte eine Einhaltung gesetzlicher Vorschriften nicht mehr gewährleisten und für den Benutzer zu einem Sicherheitsrisiko werden.</p>
<p>Risque d'explosion si la batterie n'est pas d'compatible. Les piles doivent être recyclées quand cela est possible. Le rejet des batteries usagées doit être effectué en fonction des réglementations locales.</p>	<p>Si vous n'utilisez pas le modèle d'alimentation GB-BR fourni, vous pouvez transgresser la conformité réglementaire et peut exposer l'utilisateur à des risques de sécurité.</p>
<p>Riesgo de explosión si se reemplaza la batería por una incorrecta. Las baterías deben ser reciclados donde sea posible. Eliminación de baterías usadas debe ser de acuerdo con las regulaciones ambientales locales.</p>	<p>Si no se utiliza el adaptador de corriente incluido modelo GB-BR pueda violar el cumplimiento normativo y puede exponer al usuario a riesgos de seguridad.</p>
<p>Risco de explosão caso a bateria seja substituída por tipo errado. Baterias devem ser recicladas. O descarte de baterias usadas devem ser feitas em locais de acordo com o regulamento ambiental.</p>	<p>O não cumprimento na utilização da fonte de energia modelo GB-BR incluso, pode violar o regulamento e pode expor o usuário a riscos de segurança.</p>
<p>Rischio di esplosione della batteria se sostituita con una non corretta. Le batterie devono essere riciclate dove possibile. Lo smaltimento delle batterie usate deve essere svolto in accordo con la regolamentazione locale.</p>	<p>Il mancato utilizzo della dotazione del modello GB-BR Power Adapter può violare la conformità normativa e può esporre l'utente a rischi per la sicurezza.</p>
<p>Характеристики батареи отличные от оригинальных могут привести к разрушению корпуса элемента (микровзрыву). Ипользованные батареи должны быть утилизированы в соответствии с рекомендациями местных регулирующих органов.</p>	<p>Применение стороннего блока питания отличного от устройства из комплекта поставки модели GB-BR может повлечь за собой нарушение нормативных требований и правил техники безопасности.</p>
<p>Istnieje ryzyko wybuchu, w razie zastosowania nieodpowiedniego typu baterii. Zużyte baterie mogą być odpadami niebezpiecznymi. Zużyte baterie powinny być zatem segregowane i utylizowane w miejscach do tego przeznaczonych.</p>	<p>Użycie innego zasilacza niż dostosowany do modelu GB-BR może spowodować uszkodzenie sprzętu, a także być niebezpieczne dla zdrowia.</p>
<p>Yanlış şekilde pil takildiginde patlama tehlikesi bulunmaktadir. Piller mümkün olduğunda geri dönüştürülmelidir. Kullanılmış piller yerel çevresel düzenlemelere uygun olarak atık işleme tesislerine gidecek şekilde atılmalıdır.</p>	<p>Güvenlik Uyarısı: GB-BR Güç Adaptörünün kullanılmaması kullanıcuya ve cihazı zarar verebilir.</p>
<p>若以不正確類型的電池進行更換，可能有爆炸的危險。應儘可能回收電池。應依照當地環保法規妥善使用過的電池。</p>	<p>若未使用隨附的 GB-BR 型號電源變壓器，可能會違反規範合規性，並讓使用者暴露於危險中。</p>
<p>若以不正確類型的電池進行更換，可能有爆炸的危險。應尽可能回收電池。應依照當地環保法規妥善使用過的電池。</p>	<p>不使用隨附贈的 GB-BR 型号电源适配器，可能不符合规格，并给用户的人身安全带来危險。</p>
<p>在開啟替換內部元件前，須優先斷電，並且在3分鐘後才可打開機殼。</p>	<p>GB-BR に付属の電源アダプターと電源ケーブルは専用品となります。他の機器で使用しないで下さい。安全上の問題や各種規制違反になる場合がございます。</p>
<p>在開壳替換內部元件前，須優先斷電，並且在3分鐘後才可打開机壳。</p>	<p>제공된 GB-BR 전원 어댑터를 사용하지 않은 것은 관련 규정을 어긴 것이며 이로인해 안전상의 위험에 노출될 수 있습니다.</p>
<p>Before you open chassis to exchange a internal component, you need to power off the device and let the device cool down at least 3 minutes.</p>	<p> CAUTION! Hot Surface. Do not touch. 警告、發燙表面、請勿觸碰。</p>
<p>間違ったバッテリーの交換は、破裂など事故の原因になります。可能であればバッテリーはなるべくリサイクルしてください。使用済みバッテリーは地域の環境規制に従い処理してください。</p>	<p> At the end of its serviceable life, this product should not be treated as household or general waste. It should be handed over to the applicable collection point for the recycling of electrical and electronic equipment, or returned to the supplier for disposal.</p>
<p>배터리를 잘못된 타입으로 교체하면 폭발 위험이 있습니다. 가능한한 배터리를 재활용하십시오. 수명이 다한 배터리는 현지지의 환경 규정에 따라 폐기해야 합니다.</p>	<p> This device complies with Part 15 of the FCC Rules. Operations is subject to the following two conditions: (1) this device may not cause harmful interference, and (2) this device must accept any interference received, including interference that may cause undesired operation.</p>

 **HDMI**[™]
HIGH DEFINITION MULTIMEDIA INTERFACE



25ME0-QX3D00-Q0H
产地：台灣 Made in Taiwan

GIGA-BYTE TECHNOLOGY CO., LTD.

No.6, Bao Chiang Road, Hsin-Tien Dist., New Taipei City 231, Taiwan <http://www.gigabyte.com>

©2015 GIGABYTE Technology Co., Ltd. All rights reserved. The marks mentioned herein are trademarks or registered trademarks of GIGABYTE Technology Co., Ltd. or its affiliates. All other product names mentioned herein are trademarks or registered trademarks or their respective owners. The terms HDMI and HDMI High-Definition Multimedia Interface, and the HDMI Logo are trademarks or registered trademarks of HDMI Licensing LLC in the United States and other countries.

技嘉科技股份有限公司

新北市新店區寶強路6號

GIGABYTE[™]



BRiX & BRiXs Ultra Compact PC Kit

BRiX & BRiXs Ultrakompaktes PC Kit / Kits PC ultra compact BRiX & BRiX s

PC Kit Ultra compacto BRiX y BRiXs / BRiX & BRiXs Kit PC Ultra Compacto

Kit PC Ultra Compatto BRiX / Ультеракомпактний ПК BRiX: Комплект для самостоятельной сборки

GB-BR 系列超微型電腦 / BR 系列超微型台式计算机

BRiX & BRiX s ウルトラ・コンパクト PC キット / BRiX & BRiX s 울트라 컴팩트 PC 키트

Quick Start Guide

Schnellstartanleitung / Guide de démarrage rapide / Guía de inicio rápido / Guia de Início Rápido

Guida Rapida / Руководство по быстрой сборке / Skrócona instrukcja obsługi

Hızlı Başlangıç Kilavuzu / 快速入門使用者手冊 / 快速入門用戶手冊

クイック・スタート・ガイド / 빠른 시작 설명서

Getting Familiar with Your Unit

Lernen Sie ihr Geräts kennen / Découvrez votre unité / Conozca su dispositivo / Conhecendo a sua unidade / Scopri la tua unità / Первое знакомство с устройством / Prezentacja zestawu / Cihazınızı daha iyi tanıyın

認識您的裝置 (系統操作溫度 0℃~35℃) / 熟悉您的設備 / 自分的 BRiX について詳しくなろう / 장치 숙지하기

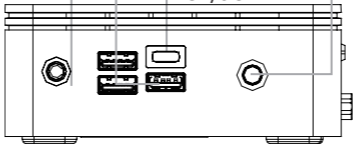
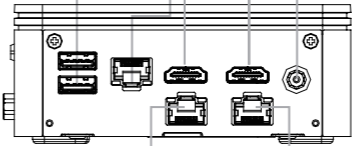
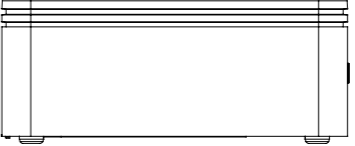
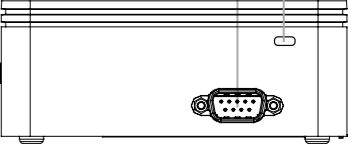
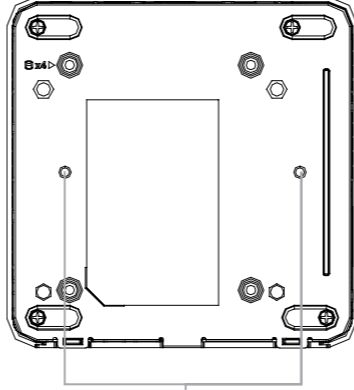
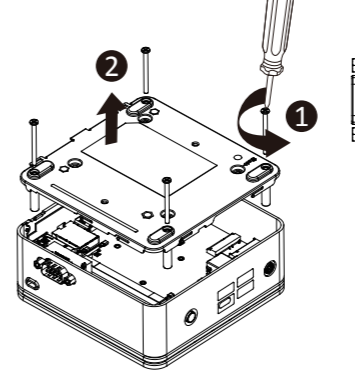
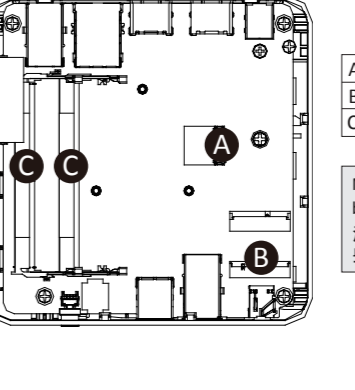
<p>【Front】</p> <p>3 x USB 3.2 Gen 2 Power Headphone USB 3.2 Gen 2 Type C, 5V/0.9A</p> 	<p>【Rear】</p> <p>RJ-45 (10/100/1000Mbps) 2 x USB 3.2 Gen 2 HDMI 2.0a DC-In</p> 	<p>【Left】</p> 	<p>【Right】</p> <p>Kensington lock slot COM</p> 
<p>【Bottom】</p>  <p>VESA Bracket Screw Hole</p>	<p>COM (RJ-45) (Optional/選配 Only available on selected models)</p> 	<p>RJ-45 (10/100/1000Mbps) (Optional/選配 Only available on selected models)</p> 	<p>【PIN Definition】</p> <p>A) WiFi connector B) M.2 2230 SSD connector C) DDR4 SO-DIMM slot</p> <p>Note: Wireless module inclusion may vary based on local distribution. 注意：根据各地经销商之产品规格配置，有些市场将不提供预载的无线模块。</p>

A) Wireless Module: How to Safely Remove the Module

Wireless-Modul: Das sichere entfernen des Moduls / Module sans fil : Comment retirer le module en toute sécurité / Módulo Inalámbrico: Cómo eliminar de forma segura el módulo

Módulo Wireless: Como remover o módulo com segurança / Modulo Wireless: Come rimuovere con sicurezza il modulo

Модуль беспроводной связи: Как безопасно удалить модуль / Modul bezprzewodowy: Jak bezpiecznie usunąć modul / Kablosuz Modülü : Modülü Nasıl Güvenli Kaldırabilirim

移除隨機搭配的無線模組 / 移除随机搭配的无线模块 / ワイヤレスモジュール : 安全にモジュールを取り外す方法 / 무선 모듈: 모듈을 안전하게 제거하는 방법

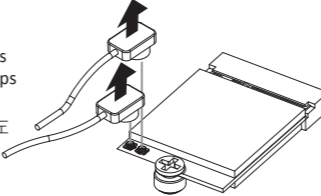
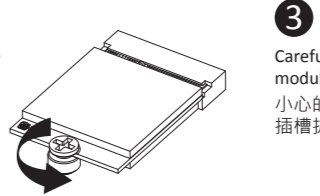
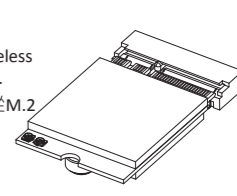
<p>1</p> <p>Disconnect the two antennas by manually lifting off the clips that hold them in place. 向上移除連接於無線模組左側頂端天線。</p> 	<p>2</p> <p>Remove the screw in the middle. 鬆開固定於無線模組中央頂端的螺絲。</p> 	<p>3</p> <p>Carefully pull the wireless module from the slot. 小心的把無線模組從M.2插槽拔除。</p> 
<p>依據低功率電波輻射性電機管理辦法【第十二條】經型式認證合格之低功率射頻電機，非經許可公司、商號或使用者均不得擅自變更頻率、加大功率或變更原設計之特性及功能。【第十四條】低功率射頻電機之使用不得影響飛航安全及干擾合法通信；經發現有干擾現象時，應立即停用，並改善至無干擾時方得繼續使用。前項合法通信指依電信法規定作業之無線電通信。低功率射頻電機須忍受合法通信或工業、科學及醫療用電波輻射性電機設備之干擾。」</p>		

Package Contents

Lieferumfang / Contenu de l'emballage / Contenido del paquete / Conteúdo do Pacote / Contenuto Confezione

Комплект поставки / Przewodnik użytkownika / Paket içeriği / 包裝內容物 / 包裝內容物 / パッケージの内容

패키지 내용물

	
	
<p>1 x GB-BR Bare-bone</p> <ul style="list-style-type: none">- NOT Include any of the following: M.2 (2280), 2.5" HDD, SO-DIMM memory- Folgende Artikel sind NICHT enthalten: M.2 (2280), 2.5" HDD, SO-DIMM-Speicher- Composants non inclus: M.2 (2280), Disque Dur 2.5", Mémoire SO-DIMM- No include: M.2 (2280), 2.5" HDD, memoria SO-DIMM- Não inclui: M.2 (2280), 2.5" HDD, memória SO-DIMM- Non include: M.2 (2280), 2.5" HDD, memoria SO-DIMM- Следующие позиции не включены в комплект поставки: M.2 (2280), 2,5-дюйм накопитель, SO-DIMM модули ОЗУ- Zestaw nie zawiera: M.2 (2280), 2.5" oraz, pamięci SO-DIMM- Sunilar dahil değildir: M.2 (2280), 2.5" HDD, SO-DIMM hafıza- 不包含下列任何項目：M.2 (2280)、2.5" 硬碟、SO-DIMM 記憶體- 不包含下列任何項目：M.2 (2280)、2.5" 硬盤、SO-DIMM 內存- 後記のものはこれに含まれていません：M.2 (2280), 2.5" HDD, SO-DIMM メモリ- 이 포함항목: M.2 (2280), 2.5" HDD, SO-DIMM memory	<p>1 x VESA Mount Bracket & 6 x Screws</p> <p>90W Adapter: 19.0Vdc,4.74A 135W Adapter: 19.5Vdc,6.92A</p> <p>GB-BRi3H-10110 : 1 x 90W Adapter & Power Cord GB-BRi5H-10210 : 1 x 135W Adapter & Power Cord GB-BRi5H-10210E : 1 x 135W Adapter & Power Cord GB-BRi7H-10510 : 1 x 135W Adapter & Power Cord GB-BRi7H-10710 : 1 x 135W Adapter & Power Cord</p> <p>1 x Driver CD</p> <p>1 x Quick Start Guide</p>

B) M.2 SSD: How to Install the M.2 2230 SSD

M.2 SSD: Wie Sie die M.2 SSD installieren / SSD M.2: Comment l'installer / M.2 SSD: Cómo instalar SSD M.2 / SSD M.2: Como instalar o SSD M.2 / M.2 SSD: Come installare un' unità M.2 SSD

Накопитель M.2 SSD: Порядок установки накопителя M.2 SSD / M.2 SSD: M.2 SSD nasıl kurulur yapılır / 如何安裝 M.2 SSD / 如何安裝 M.2 SSD

M.2 SSD : M.2 SSD の取り付け方法 / M.2 SSD : M.2 방식 SSD 을 설치하는 방법

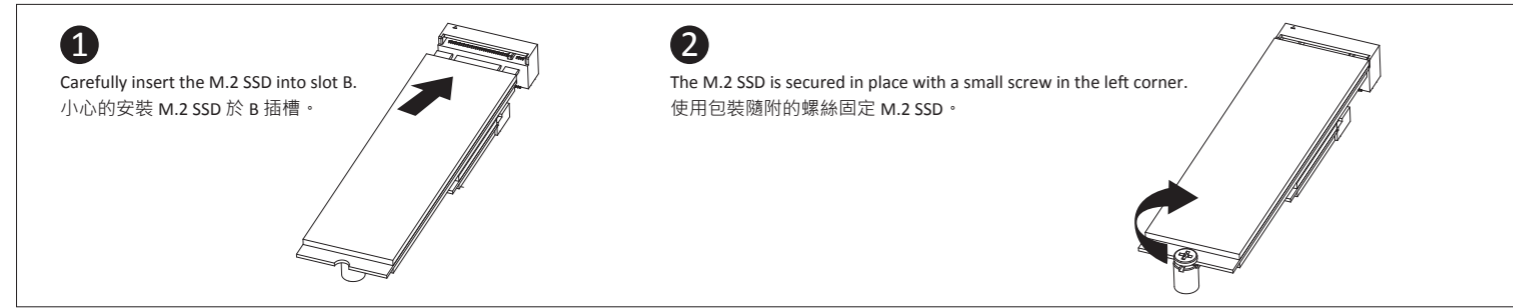

C) Memory Installation: SO-DIMM DDR4

Arbeitsspeicher Installation DDR4 / Installation de la mémoire DDR4 / Instalación de la Memoria DDR4 / Instalação da memória DDR4 / Installazione Memoria DDR4 / Установка модулей ОЗУ DDR4

Instalacja pamięci DDR4 / Bellek Yerleştirilmesi DDR4 / 安裝記憶體 / 安裝内存 / メモリの増設方法 DDR4 / 메모리 설치 DDR4

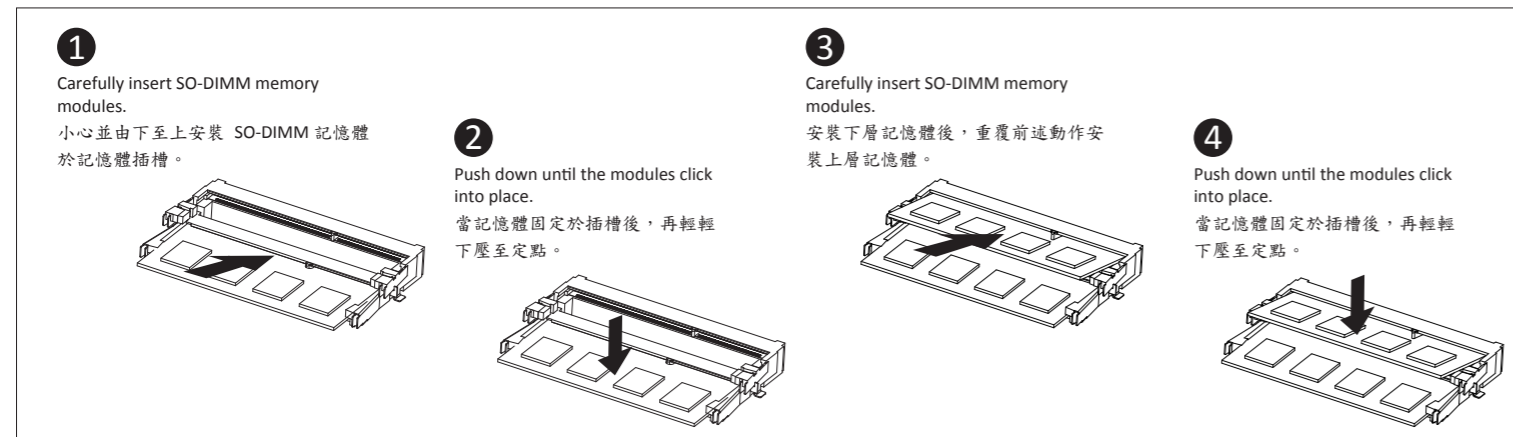

D) BRiX s Support Additional SATA 6Gbps HDD: How to Install 2.5" HDD

BRiX s Unterstützt Zusätzliche SATA 6Gbps HDD: So installieren Sie die 2,5 "Festplatte / Le BRiX s supporte un disque dur SATA 6Gbps additionel: Comment l'installer

Soporte adicional HDD 6Gbps SATA para BRiXs: Cómo instalar HDD 2.5" / BRiX s Suporte adicional para HDD SATA 6Gbps: Como instalar HDD 2.5"

BRiX Supporta un' ulteriore porta SATA 6Gbps per HardDisk: Come installare un HDD da 2,5" / BRiX допускает установку дополнительного жесткого SATA-диска (6 Гбит/с): Порядок установки 2,5-дюймов жесткого диска

BRiX wspiera dodatkowy dysk SATA 6Gbps HDD: Jak zainstalować 2.5" HDD / BRiX, extra 6Gbps HDD destekler: 2.5" HDD nasıl kurulur yapılır / BRiX s 支援額外的 SATA 6Gbps 硬碟: 如何安裝 2.5" HDD

BRiX s 支援額外的 SATA 6Gbps 硬碟: 如何安裝 2.5" HDD / BRiXs SATA 6Gbp 하드디스크(HDD) 증設: 2.5-인치 HDD의取り付け方法 / BRiX s 는 추가 SATA 6Gbps 을 지원합니다. HDD : 2.5" HDD 를 설치하는 방법

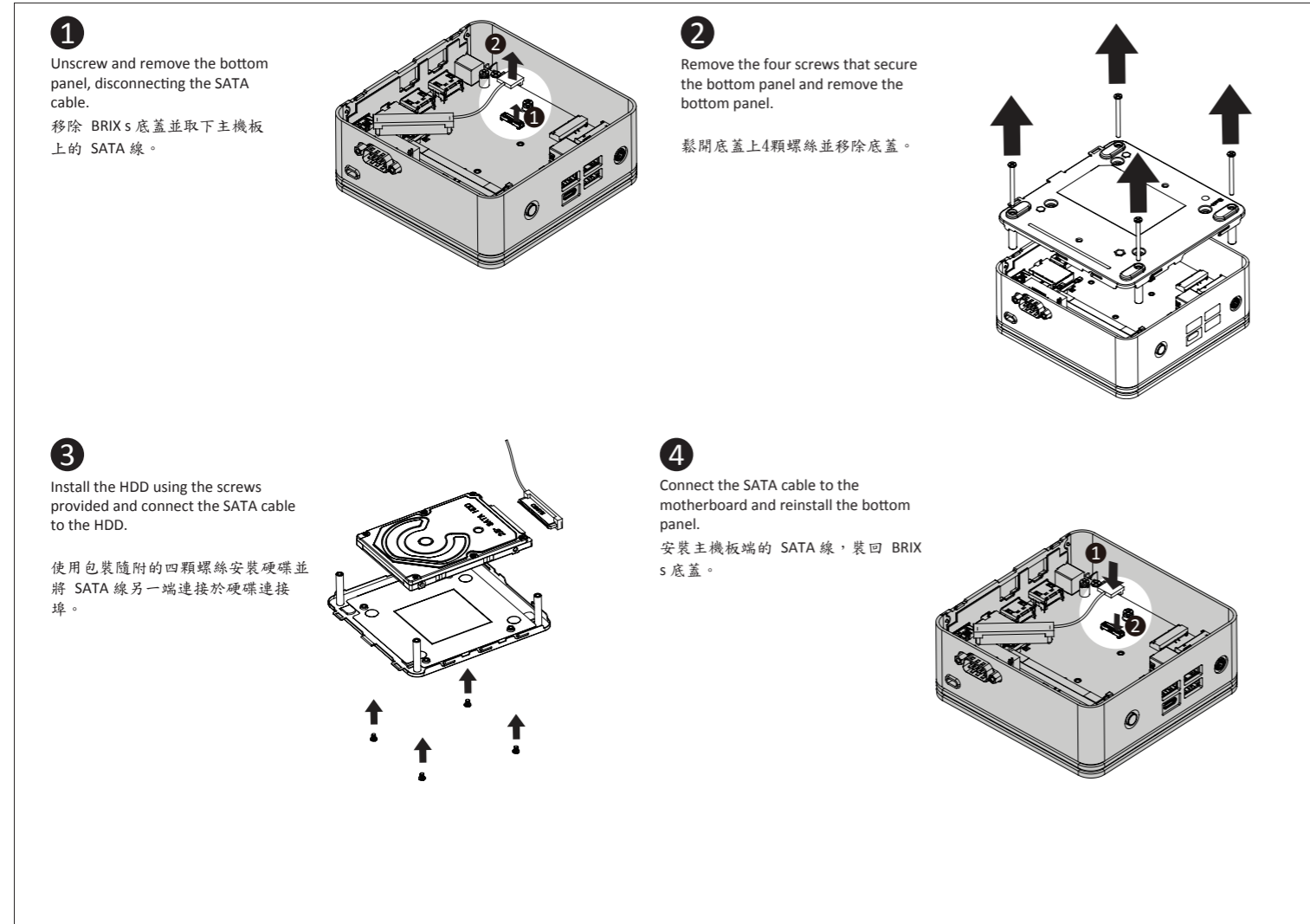

VESA Bracket

VESA-Halterung / Support VESA / soporte VESA / Suporte VESA / Staffa VESA / Крепление VESA / Uchwyt VESA / VESA Desteği / VESA 支架 / VESA 支架 / VESA 対応ブラケット / VESA 브래킷

NOTE! VESA screws: Length 5.0 mm with M3 type screws, Metal enclosure with bottom side.

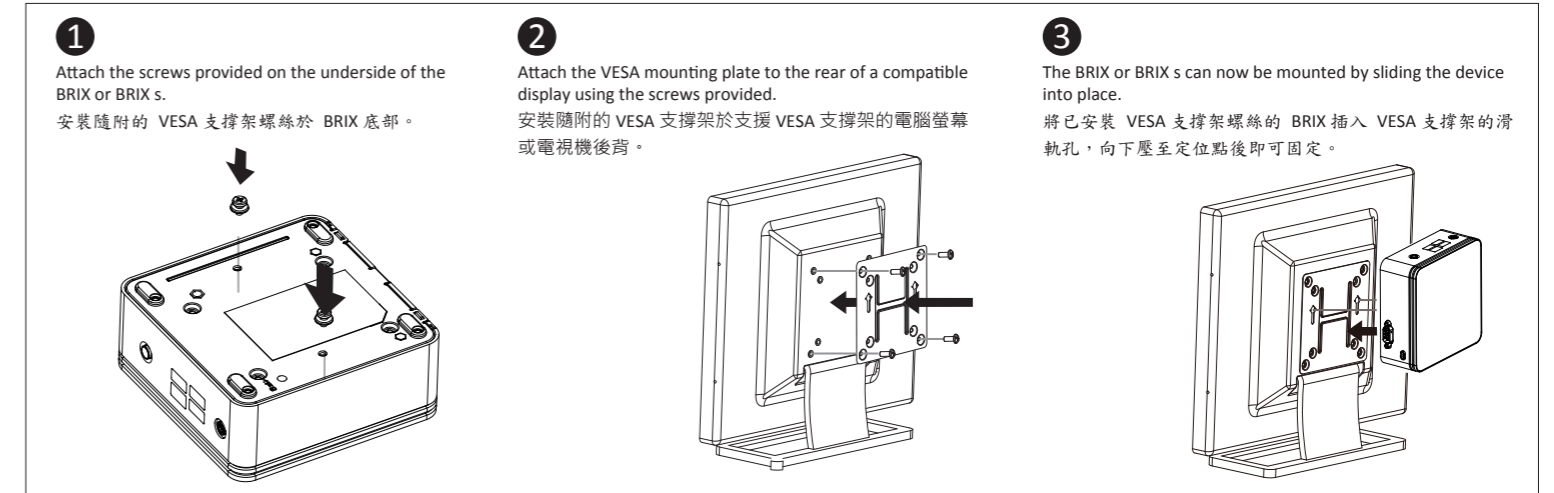

USB Power On Function: Allows Device Power-on Via USB. Useful When Mounted Behind a Display or TV

USB Power On Funktion / Fonction Démarrage par USB / Función USB Power On

Função USB Power On / Funzione USB Power On / Функция USB Power On

Orçja USB Power On / USB Güç Açık Fonksiyonu / USB 埠啟動功能

USB 接口启动功能 / USB 機器からの電源 ON 機能 / USB 포트를 이용한 전원 켜기

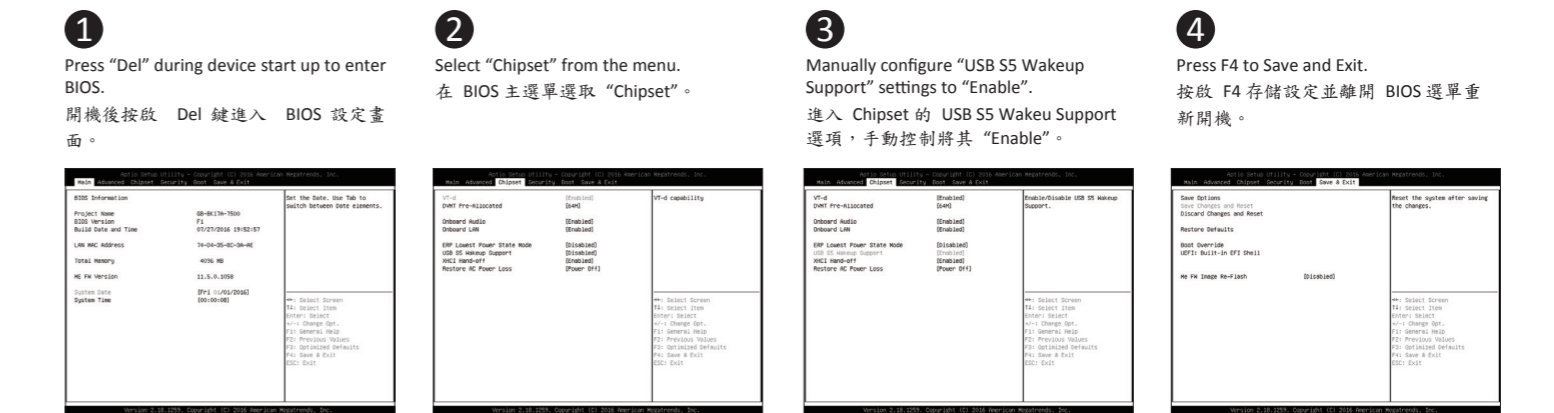

Note: 'USB Power On' functionality in Windows requires an additional Windows patch. This is provided on GIGABYTE's official website labeled 'USB Power-On Patch'. Your GIGABYTE BRiX can be powered on via a connected USB device such as a keyboard or mouse, offering greater convenience when mounted behind a display or monitor.

注意: 在 Windows 的版本環境下需要額外的應用程式來啟動 "USB Power On" 功能。你可以透過技嘉官網的產品支援與更新下載 "USB Power-On Patch" 來執行。USB Power On 提供了方便的開機功能, 使用者可以透過連接到 BRiX 上的 USB 裝置啟動 BRiX; 讓安裝於顯示器後方的 BRiX 更方便使用。

單元 Unit	限用物質及其化學符號 Restricted substances and its chemical symbols					
	鉛Lead (Pb)	汞Mercury (Hg)	鎘Cadmium (Cd)	六價鉻 Hexavalent chromium (Cr ¹⁶)	多溴聯苯 Polybrominated biphenyls (PBB)	多溴二苯醚 Polybrominated diphenyl ethers (PBDE)
電路板總成	—	○	○	○	○	○
外殼	—	○	○	○	○	○
電源供應器	—	○	○	○	○	○
線材	—	○	○	○	○	○
無線網路卡	—	○	○	○	○	○

備考1. "超出0.1 wt %" 及 "超出0.01 wt %" 係指限用物質之百分比含量超出百分比含量基準值。
Note 1: "Exceeding 0.1 wt %" and "exceeding 0.01 wt %" indicate that the percentage content of the restricted substance exceeds the reference percentage value of presence condition.

備考2. "○" 係指該項限用物質之百分比含量未超出百分比含量基準值。
Note 2: "○" indicates that the percentage content of the restricted substance does not exceed the percentage of reference value of presence.

備考3. "-" 係指該項限用物質為排除項目。
Note 3: The "--" indicates that the restricted substance corresponds to the exemption.