



Make It Yours.

# CALIBER R3C

Cooler Master Gaming Chair



[www.coolermaster.com/warranty/](http://www.coolermaster.com/warranty/)



[www.coolermaster.com](http://www.coolermaster.com)



**North America - Cooler Master NA**  
1 N Indian Hill Blvd, Suite 200,  
Claremont, CA 91711, USA  
Tel: +1-888-624-5099

**Europe - Cooler Master Europe B.V.**  
Lodewijkstraat 1b, 5652AC Eindhoven,  
The Netherlands  
Tel: +31-(0)40-702-0900

**China - Cooler Master China**  
7th Floor, Building C, Hongqiao R&F  
Center, No.7, 958 Lane, Shenhong Rd.,  
Minhang District, Shanghai City 200051,  
China  
Tel: +86-21-51872177

Cooler Master Support:  
<https://account.coolermaster.com>

©2019 Cooler Master Technology Inc. All right  
Reserved. All trademarks are registered to their  
respective owners. Designed by Cooler Master.  
Made in China.



**Cooler Master Website**  
For the most updated  
information, please visit  
our official website:  
[www.coolermaster.com](http://www.coolermaster.com)



Make It Yours.



# CALIBER R3C

Cooler Master Gaming Chair  
Instruction Manual

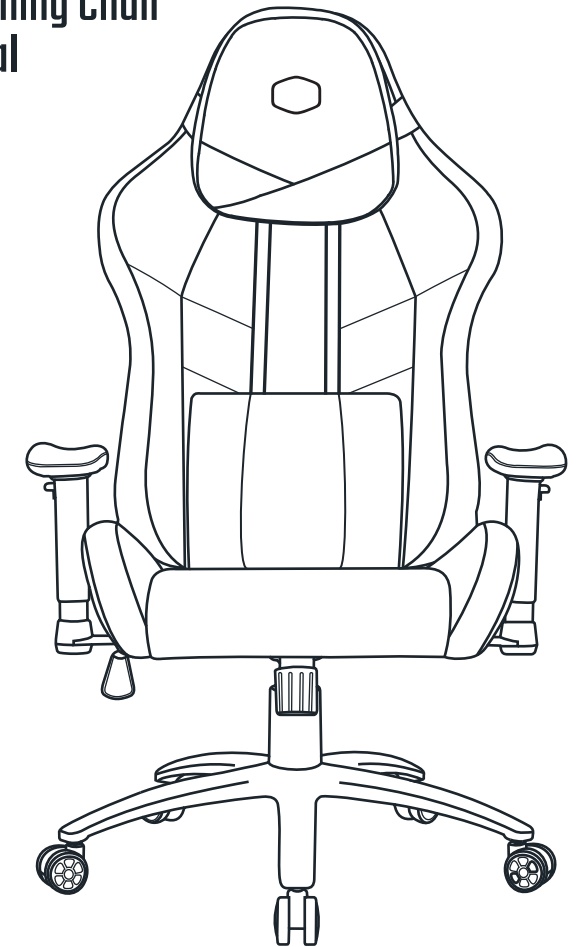

Installation Video





# CALIBER R3C

Cooler Master Gaming Chair







## CONTENTS

---

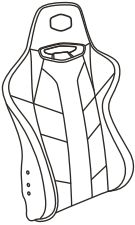
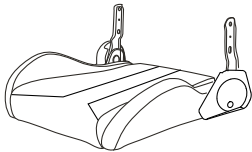
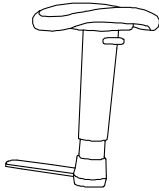
Package Content	2
Installation Guide	3
• Installation Steps	3
• Completing Installation	3
Chair Dimensions	4
Warranty Information	6

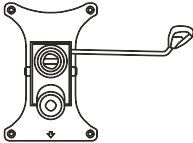
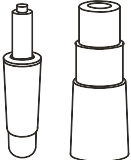
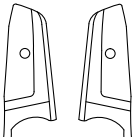
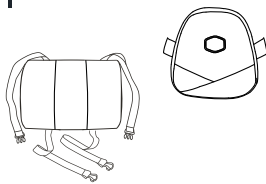

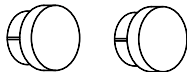
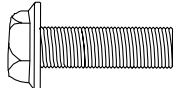
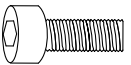
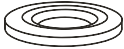
PACKAGE CONTENT

<p><b>A</b></p>  <p>Backrest x 1</p>	<p><b>B</b></p>  <p>Seatbase x 1</p>	<p><b>C</b></p>  <p>Armrest x 2</p>
<p><b>D</b></p>  <p>Five-star metal base x 1</p>	<p><b>E</b></p>  <p>Performance wheels x 5</p>	<p><b>F</b></p>  <p>Tilt Mechanism x 1</p>
<p><b>G</b></p>  <p>Gas lift / Cover x 1</p>	<p><b>H</b></p>  <p>Recliner mechanism covers x 2</p>	<p><b>I</b></p>  <p>Lumbar support x 1 / Head pillow x 1</p>
<p><b>J</b></p>  <p>Universal tool x 1</p>	<p><b>K</b></p>  <p>Cover studs x 2</p>	<p><b>L</b></p>  <p>(M8* 25mm) x 14</p>
<p><b>M</b></p>  <p>(M5* 8mm) x 2</p>	<p><b>N</b></p>  <p>Flat washers x 14</p>	<p><b>O</b></p>  <p>Lock washers x 14</p>

INSTALLATION GUIDE

**Step1**

A x1  
B x1  
J x1  
L x4  
N x4  
O x4

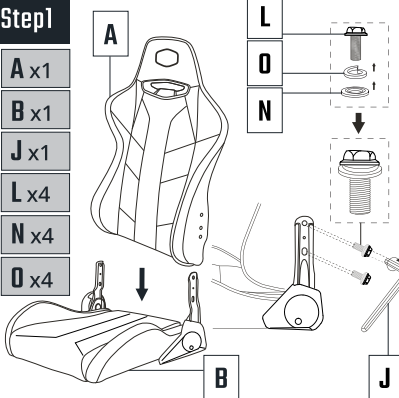

Diagram showing the backrest (A) and seatbase (B) being attached to the armrests (J) using screws (L, N, O).

**Step2**

C x2  
F x1  
J x1  
L x10  
N x10  
O x10

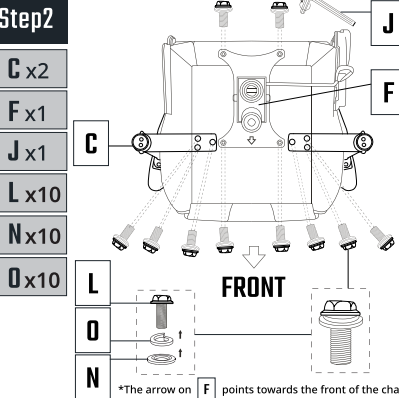

Diagram showing the seatbase (B) being attached to the five-star metal base (D) using screws (L, N, O) and the tilt mechanism (F). The front of the chair is indicated.

\*The arrow on F points towards the front of the chair

**Step3**

H x2  
J x1  
K x2  
M x2

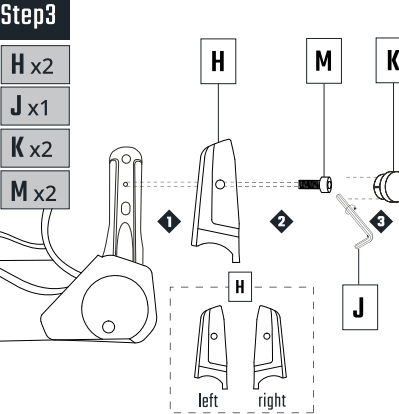

Diagram showing the recliner mechanism covers (H) being attached to the seatbase (B) using screws (J, K) and the gas lift/cover (G). The left and right sides are indicated.

**Step4**

D x1  
E x5  
G x1

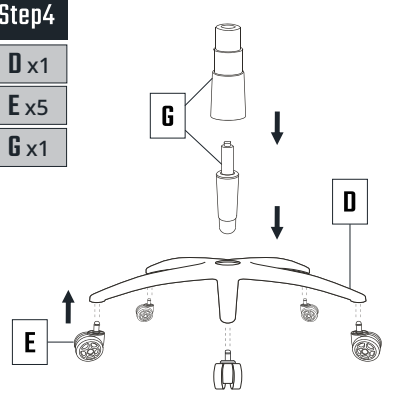

Diagram showing the gas lift/cover (G) being attached to the five-star metal base (D) using the universal tool (J). The wheels (E) are then attached to the base.

**Step5**

I x1

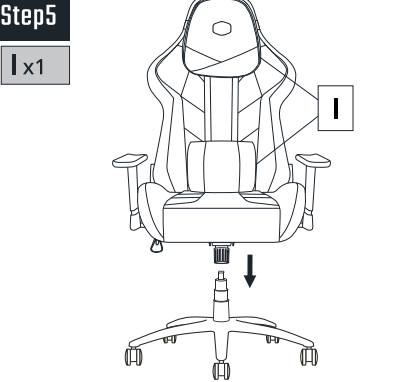

Diagram showing the lumbar support (I) being attached to the backrest (A) using the universal tool (J).

**Complete**

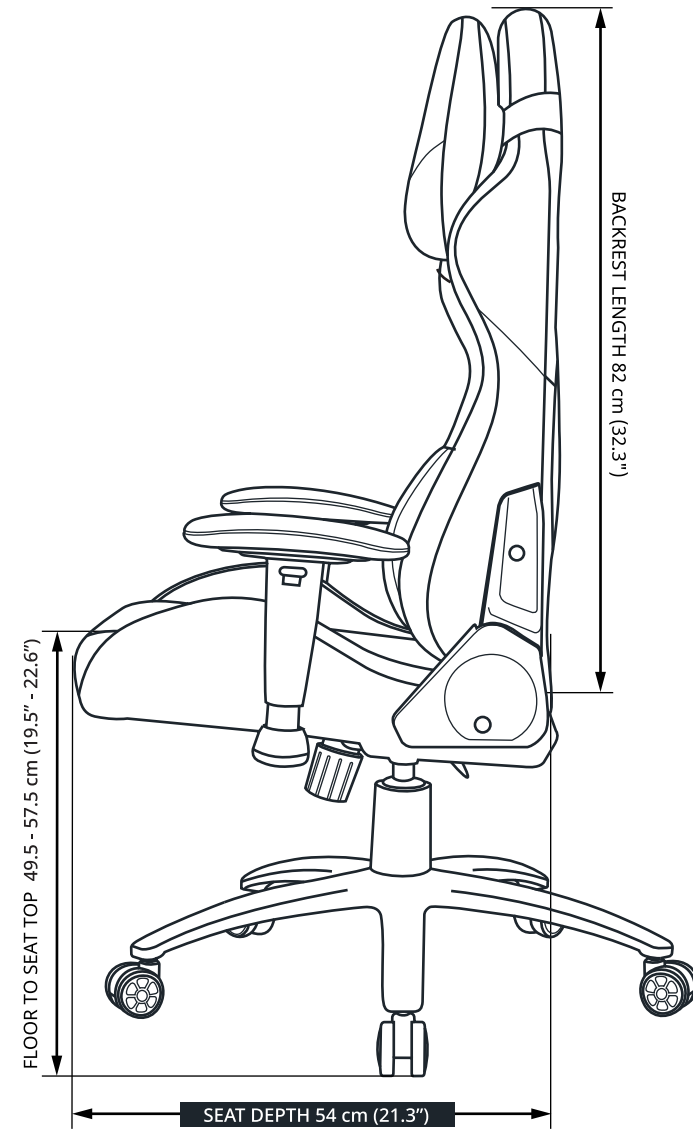
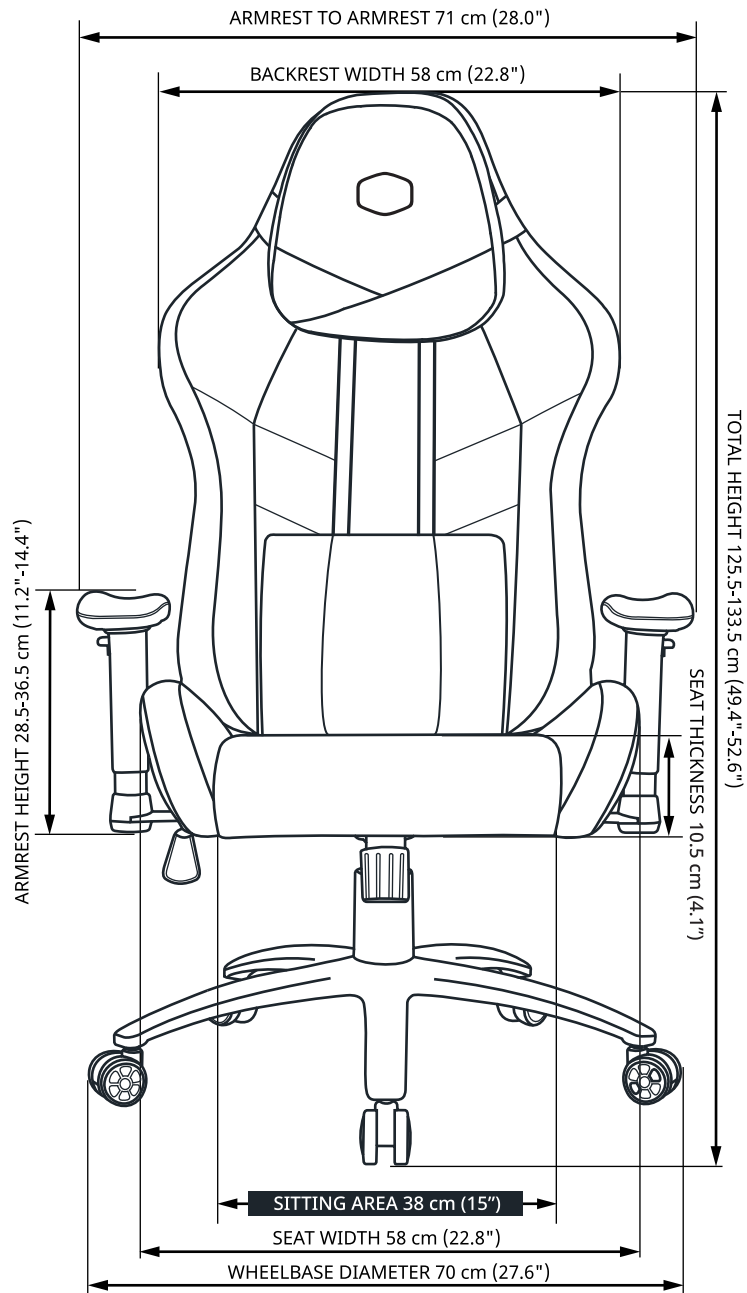

Diagram showing the fully assembled chair.



# CALIBER R3C GAMING CHAIR

# CHAIR DIMENSIONS



<p><b>English (EN)</b></p> <p>Cooler Master provides a two-year limited hardware warranty for this device commencing from the date of purchase. Please keep your receipt for proof of purchase. The warranty offered covers normal use. Defects or damage that results from improper operation, misuse, abuse, accidents, or negligence of the product, which is not the fault of Cooler Master, will be excluded from warranty coverage.</p> <p>The warranty is voided by removal or alternation of products or parts identification labels.</p> <ol style="list-style-type: none"> <li>In the case of a conflict between the warranty provided by the country of point of sale and this manual, the warranty of the country of point of sale shall be the prevailing document.</li> <li>In the case of a malfunction of electronic components or the needs for purchasing accessories during the warranty period, please return to the original store of purchase.</li> </ol>	<p><b>Arabic (AR)</b></p> <p>نم آرد بيوع قديم زاهالما اذة تانوكيم ولع اودوجم انامهم رقبوي مادختساليا نامضلا بطغي ،انوشلا ثابتال لاصي اولاب طافتجالا يجري ،مارشلا عيزوت وس واهلسرلا ريغ لبيغشانا نوح عتاتن راضيا و بسوي وا يونتستيت ،طقف يداعل يف بيوج سايولو .جنتجنت مادختسا يف لامبالا و اذواجلا و اذواجلا و مادختساليا .جنتجنت مادضلا نامضلا نم ،Cooler Master</p> <p>جخطوقلا فيريعت تقاطب قلازا و اذواجلا لبيجت و اذفب نامضلا يغلي</p> <ol style="list-style-type: none"> <li>ليدلا اذو قنودا يف بيوجلا فظوق لبق نم جخطوقلا نامضلا اضراعت قلاخ يف ، دواسلا اذوسرلاما و عي سالا فظوق نامضف</li> <li>اخر جخطوقلا لاصي لامرلا نامضلا و فيزوتتواتلالا تانوكيملا يف لطع اضراع قلاخ يف ، انوشلا دم بت يذلا لوصالما رجتملا ول اذوجورلا يجري نامضلا قرتف لالغ فظوق نم</li> </ol>
<p><b>Bulgarian (BG)</b></p> <p>Cooler Master предоставя двугодишна ограничена гаранция за хардуера на това устройство, която започва да важи от датата на закупуване. Плазете касовата бележка като доказателство за покупката. Предлаганата гаранция покрива нормална употреба. Дефекти или повреди в резултат от работа, неправилна употреба, злоупотреба, злополука или небрежност спрямо продукта, за които Cooler Master не носи вина, ще бъдат изключени от покритието на гаранцията. Гаранцията се анулира, в случай че идентификационните етикети на продукти или части са отстранени или преправени.</p> <ol style="list-style-type: none"> <li>В случай на конфликт между гаранцията, предлагана от държавата на закупуване, и това ръководство, гаранцията на държавата на закупуване е документът с по-висок приоритет.</li> <li>В случай на неизправност на електронни компоненти или при необходимост да се закупят аксесоари по време на гаранционния период, обърнете се към магазина, от който първоначално сте закупили продукта.</li> </ol>	<p><b>Czech (CS)</b></p> <p>Cooler Master poskytuje na toto zařízení dvouletou omezenou záruku na technické vybavení, jejíž platnost začíná dnem nákupu. Laskavě si uschovejte účtenku jako důkaz, že jste si výrobek koupili. Nabízená záruka se vztahuje k běžnému používání výrobku. Na vady nebo poškození plynoucí z nesprávného způsobu používání, zacházení a používání pro jiné než výrobcem určené účely, nehody nebo nedbalost při zacházení s výrobkem, za které nenese odpovědnost společnost Cool Master, se záruka nevztahuje. Platnost záruky končí, pokud demontujete nebo jinak pozměníte jakoukoliv součást výrobku, nebo pokud odstraníte identifikační štítky ze součástek výrobku.</p> <ol style="list-style-type: none"> <li>V případě rozdílu mezi zárukou poskytnutou v zemi, ve které byl výrobek prodán, a tímto návodem, platí dokument popisující záruku v zemi prodeje.</li> <li>V případě poruchy elektronických součástí nebo pokud bude nutné koupit příslušenství v průběhu záruční doby, vraťte výrobek na prodejní, ve které jste jej koupili.</li> </ol>
<p><b>Chinese (繁體中文)</b></p> <p>Cooler Master 提供本設備二年之硬體有限保固服務。自購買日起算。請把您的收據放在安全之處，以免Cooler Master要求您提供本證明。</p> <p>保固服務僅適用於正常使用下之故障情形。若本公司發現設備損壞之原因為濫用、改造、誤用、疏忽、電壓供應錯誤、空氣及水污染意外和自然災害，則保固無效。若重點或條碼遭毀損而無法辨識保固期限者，則不適用保固服務。</p> <ol style="list-style-type: none"> <li>若銷售國家所提供的保固與本說明互有衝突時，應以實際銷售國家之保固為準。</li> <li>保固期內遇有電子零件故障或配件購買需求，請洽原購買商店協助。</li> </ol>	<p><b>Chinese (簡體中文)</b></p> <p>Cooler Master 提供本设备二年之硬件有限保固服务。自购买日算起。请把您的收据放在安全之处，以免Cooler Master要求您提供本证明。</p> <p>保固服务仅适用于正常使用下之故障情形。若本公司发现设备损坏之原因为滥用、改造、误用、疏忽、电压供应错误、空气及水污染意外和自然灾害，则保固无效。若重点或条形码遭毁损而无法辨识保固期限者，则不适用保固服务。</p> <ol style="list-style-type: none"> <li>若销售国家所提供的保固与本说明互有冲突时，应以实际销售国家之保固为准。</li> <li>保固期内遇有电子零件故障或配件购买需求，请洽原购买商店协助。</li> </ol>
<p><b>German (DE)</b></p> <p>Cooler Master bietet ab Kaufdatum eine zweijährige eingeschränkte Hardware-Garantie für diese Gerät. Bitte bewahren Sie Ihren Kaufbeleg auf. Die angebotene Garantie deckt den normalen Gebrauch ab. Mängel oder Schäden aufgrund von unsachgemäßer Verwendung, Missbrauch, falschem Gebrauch, Unfällen oder Fahrlässigkeit, die nicht auf Cooler Master zurückzuführen sind, sind von der Garantieabdeckung ausgeschlossen. Die Garantie erlischt bei Entfernung oder Änderung von Produkten, Teilen oder Kennzeichnungen.</p> <ol style="list-style-type: none"> <li>Bei einem Konflikt zwischen der von der Verkaufsstelle in Ihrem Land bereitgestellten Garantie und dieser Anleitung hat die Garantie Ihrer Verkaufsstelle Vorrang vor dem Dokument.</li> <li>Falls es während der Garantiedauer zu einer Fehlfunktion elektronischer Komponenten kommt oder Zubehör erworben werden muss, geben Sie das Produkt bitte an den ursprünglichen Händler zurück.</li> </ol>	<p><b>Greek (EL)</b></p> <p>Η Cooler Master παρέχει μια περιορισμένη εγγύηση υλικού δύο ετών για αυτή τη συσκευή, η οποία αρχίζει από την ημερομηνία αγοράς. Παρακαλούμε φυλάξτε την αποδείξη αγοράς. Η εγγύηση που παρέχεται καλύπτει την κανονική χρήση. Τα ελαττώματα ή οι ζημιές που προκύπτουν από ακατάλληλη λειτουργία, κακή χρήση, κατάρηση, ατυχήματα ή αμελεία και δεν αποτελούν ευθύνη της Cooler Master, αποκλείονται από την κάλυψη της εγγύησης. Η εγγύηση ακυρώνεται με την αφαίρεση ή την τροποποίηση προϊόντων ή ετικετών αναγνώρισης εξαρτημάτων.</p> <ol style="list-style-type: none"> <li>Σε περίπτωση διαφωνίας μεταξύ της εγγύησης που παρέχεται από τη χώρα του σημείου πώλησης και της εγγύησης που ορίζεται στο παρόν εγχειρίδιο, η εγγύηση της χώρας του σημείου πώλησης αποτελεί το επικρατέστερο έγγραφο.</li> <li>Σε περίπτωση δυσλειτουργίας τυχόν ηλεκτρονικών εξαρτημάτων ή ανάγκης αγοράς εξαρτημάτων κατά τη διάρκεια της περιόδου εγγύησης, παρακαλούμε απευθυνθείτε στο αρχικό κατάστημα αγοράς.</li> </ol>

<p><b>Spanish (ES)</b></p> <p>Cooler Master ofrece una garantía limitada de dos años para el hardware de este dispositivo a partir de la fecha de compra. Conserve su recibo como comprobante de compra. La garantía ofrecida cubre el uso normal. Los defectos o daños provocados por una operación inadecuada, mal uso, abuso, accidentes o negligencia del producto, que no sea culpa de Cooler Master, serán excluidos de la cobertura de la garantía.</p> <p>La garantía queda anulada por la eliminación o alternancia de productos o etiquetas de identificación de piezas.</p> <ol style="list-style-type: none"> <li>En caso de conflicto entre la garantía proporcionada por el país del punto de venta y este manual, la garantía del país del punto de venta será el documento que prevalezca.</li> <li>En caso de un mal funcionamiento de los componentes electrónicos o la necesidad de comprar accesorios durante el periodo de garantía, acuda de nuevo a la tienda original de compra.</li> </ol>	<p><b>French (FR)</b></p> <p>Cooler Master fournit une garantie matérielle de deux ans à compter de la date d'achat de l'appareil. Veuillez conserver votre reçu comme preuve d'achat. La garantie offerte couvre l'usage normal de l'appareil. Les défauts ou dégâts consécutifs à une utilisation inappropriée, incorrecte, abusive ou à un accident ou à la négligence du produit, et qui ne relèvent pas de la responsabilité de Cooler Master, seront exclus de la couverture de la garantie.</p> <p>La garantie sera rendue nulle par le retrait ou la modification des étiquettes d'identification du produit ou de ses pièces.</p> <ol style="list-style-type: none"> <li>En cas de litige entre la garantie fournie par le pays du point de vente et ce manuel, la garantie du pays du point de vente prévaut.</li> <li>En cas de dysfonctionnement des composants électroniques ou de nécessité d'acheter des accessoires au cours de la période de garantie, veuillez ramener le produit dans le magasin où vous avez effectué l'achat.</li> </ol>
<p><b>Korean (KR)</b></p> <p>Cooler Master는 이 제품에 대해 구매일로부터 계산하여 2년의 제한적 하드웨어 보증 서비스를 제공합니다. 구입 영수증을 보관하십시오. 제공되는 보증은 정상적으로 사용할 때 적용됩니다. 부적절한 작동, 오용, 남용, 사고, 부주의 등 Cooler Master의 과실이 아닌 원인으로 발생한 결함이나 손상은 보증 범위에서 제외됩니다.</p> <p>제품 또는 부품 식별 라벨을 제거하거나 변경하면 보증이 무효화됩니다.</p> <ol style="list-style-type: none"> <li>판매 국가에서 제공되는 보증과 이 설명서의 보증 내용이 상충하는 경우 판매 국가에서 제공되는 보증이 우선합니다.</li> <li>보증 기간 동안 전자 부품이 고장났거나 액세서리를 구매해야 하는 경우에는 이를 원래 구매할 매장에 반환하십시오.</li> </ol>	<p><b>Kazakh (KZ)</b></p> <p>Cooler Master компаниясы осы құрылғы үшін оны сатып алған күнінен бастап екі жылға шектелген кепілдікті ұсынады. Құрылғының сатып алынғанын растау үшін түбіреткі сақтан қойыңыз. Кепілдік құрылғы қалыпты пайдаланылған жағдайда ғана жарамды болады. Өнімді заңсыз пайдалану, дұрыс пайдаланбау, пайдалану шарттарын бұзу, апаттық оқиғалар немесе ұқыпсыз пайдаланудан және Cooler Master компаниясына тәуелсіз түйінді ақаулықтар мен зияндар осы кепілдікте қарастырылмайды. Өнімдердегі немесе бөлшектердегі идентификациялық белгілерді алып тастаған немесе өзгертен жағдайда кепілдіктің күші жойылады.</p> <ol style="list-style-type: none"> <li>Өнімді сатушы ел ұсынған кепілдік пен осы нұсқаулықтың арасында қайшылық болса, өнімді сатушы елдің кепілдігі басым күшке ие болады.</li> <li>Кепілдік мерзімі барысында электронды құрамдастар істен шыққан немесе керек-жақтарды сатып алу қажет болған жағдайда өнім сатып алынған дүкенге барыңыз.</li> </ol>
<p><b>Hungarian (HU)</b></p> <p>A Cooler Master kétévés korlátozott hardvergaranciát biztosít erre az eszközre a vásárlás dátumától kezdődően. Tartsa meg a nyugtát a vásárlás igazolásaként! A garancia normál használatra terjed ki. A garancia nem terjed ki nem megfelelő működtetésből, balesetektől, balesetekből, illetve a Cooler Master felelősségén kívül eső termékhiányosságból eredő károkra.</p> <p>A garancia érvényét veszti, ha a termék módosított végeznek, illetve ha eltávolítják vagy módosítják az alkatrészcsímkeket.</p> <ol style="list-style-type: none"> <li>Ha az eladás országában kötelező garancia és a jelen kézikönyv között ellentmondás van, akkor az eladás országában kötelező garancia lesz érvényes.</li> <li>Éz a elektronikus alkatrészek meghibásodása esetén, illetve ha tartozékokat szeretne vásárolni a garancia időtartama alatt, menjen vissza abba a boltba, ahol a terméket eredetileg vásárolta.</li> </ol>	<p><b>Indonesian (ID)</b></p> <p>Cooler Master memberikan garansi terbatas selama dua tahun untuk perangkat keras ini terhitung sejak tanggal pembelian. Simpan tanda terima untuk bukti pembelian. Garansi yang ditawarkan memberikan pertanggungungan untuk penggunaan normal.</p> <p>Kecelakaan atau kerusakan karena pengoperasian yang tidak semestinya, kesalahan penggunaan, penyalahgunaan, kecelakaan, atau kelalaian produk yang bukan kesalahan Cooler Master, akan dikecualikan dari pertanggungungan garansi.</p> <p>Garansi akan dibatalkan jika mengapus atau mengubah label identifikasi produk atau komponen.</p> <ol style="list-style-type: none"> <li>Jika terjadi konflik antara garansi yang disediakan oleh negara di tempat penjualan dan dalam buku panduan, maka dokumen garansi dari negara tempat penjualan yang akan diberlakukan.</li> <li>Jika terjadi kegagalan fungsi pada komponen elektronik atau Anda perlu membeli aksesoris selama masa garansi, kunjungi kembali toko pembelian awal.</li> </ol>
<p><b>Italian (IT)</b></p> <p>Cooler Master provides a two-year limited hardware warranty for this device commencing from the date of purchase. Please keep your receipt for proof of purchase. The warranty offered covers normal use. Defects or damage that results from improper operation, misuse, abuse, accidents, or negligence of the product, which is not the fault of Cooler Master, will be excluded from warranty coverage.</p> <p>The warranty is voided by removal or alternation of products or parts identification labels.</p> <ol style="list-style-type: none"> <li>In the case of a conflict between the warranty provided by the country of point of sale and this manual, the warranty of the country of point of sale shall be the prevailing document.</li> <li>In the case of a malfunction of electronic components or the needs for purchasing accessories during the warranty period, please return to the original store of purchase.</li> </ol>	<p><b>Japanese (JP)</b></p> <p>Cooler Master は、本装置に対して、その購入日から2年間の限定ハードウェア保証を提供します。購入を証明するために、領収書を保管してください。提供される保証は、通常使用を対象とします。不適切な操作・誤用・乱用・事故・Cooler Masterの落ち度ではない製品の過失に起因する欠陥または損傷は、保証の対象から除外されます。</p> <p>製品または部品の識別ラベルが取り外された場合、変更された場合、保証は無効になります。</p> <ol style="list-style-type: none"> <li>販売した国において提供される保証と本マニュアルに記載する保証の間で矛盾が発生した場合は、販売した国における保証が、本マニュアル記載の保証よりも優先されるものとします。</li> <li>保証期間中に、電気コンポーネントが故障した場合、付属品の購入が必要となった場合は、購入した店舗に返却してください。</li> </ol>

<p><b>Dutch (NL)</b></p> <p>Cooler Master biedt een beperkte hardwaregarantie van twee jaar voor dit apparaat vanaf de datum van aanschaf. Bewaar uw bon als aankoopbewijs. De aangeboden garantie dekt normaal gebruik. Defecten of schade die het gevolg is van onjuiste bediening, verkeerd gebruik, misbruik, ongevallen of nalatigheid van het product, wat niet de fout is van Cooler Master, zal uitgesloten zijn van garantiedekking.</p> <p>De garantie komt te vervallen door verwijdering of aanpassing van identificatielabels van producten of onderdelen.</p> <ol style="list-style-type: none"> <li>In het geval van een conflict tussen de garantie die wordt geboden door het land van het verkooppunt en deze handleiding, zal de garantie van het land van het verkooppunt het geldende document zijn.</li> <li>In het geval van storing van elektronische componenten of de noodzaak om accessoires aan te schaffen gedurende de garantieperiode, brengt u het terug naar de oorspronkelijke winkel van aanschaf.</li> </ol>	<p><b>Polish (PL)</b></p> <p>Produkty Cooler Master są objęte dwuletnią ograniczoną gwarancją na elementy sprzętowe, począwszy od daty zakupu. Prosimy zachować dowód zakupu. Gwarancja obejmuje tylko korzystanie z produktu zgodnie z jego przeznaczeniem. Wady i uszkodzenia powodowane niewłaściwą obsługą, użyciem niezgodnym z przeznaczeniem, wypadkami lub zaniedbaniami, które nie wynikają z winy firmy Cooler Master, nie będą objęte gwarancją.</p> <p>Wszelkie przeróbki lub usuwanie elementów produktu lub etykiet identyfikujących części powoduje utratę uprawnień gwarancyjnych.</p> <ol style="list-style-type: none"> <li>W przypadku sprzeczności między warunkami gwarancji wynikającymi z przepisów powszechnych w kraju zakupu a warunkami zawartymi tutaj, pierwszeństwo mają warunki gwarancji ustalone przepisami w kraju zakupu.</li> <li>W przypadku awarii komponentów elektronicznych lub potrzeby zakupu akcesoriów w okresie gwarancji prosimy zwrócić się do sprzedawcy, u którego oryginalnie zakupiono produkt.</li> </ol>
<p><b>Portugal (PT)</b></p> <p>A Cooler Master oferece uma garantia limitada de dois anos para o hardware deste produto, com início na data de aquisição. Guarde o seu recibo como prova de compra. A garantia oferecida abrange a utilização normal. A cobertura da garantia exclui defeitos ou danos resultantes de operações inadequadas, utilizações indevidas, abusos, acidentes ou negligência do produto, que não sejam da responsabilidade da Cooler Master.</p> <p>A remoção ou alteração do produto ou de etiquetas de identificação de componentes anulará a garantia.</p> <ol style="list-style-type: none"> <li>Em caso de um conflito entre a garantia fornecida pelo país do ponto de venda e este manual, prevalecerá a garantia do país do ponto de venda.</li> <li>Em caso de avaria dos componentes eletrónicos ou necessidade de aquisição de acessórios durante o período de garantia, o produto deve ser devolvido à loja onde foi originalmente adquirido.</li> </ol>	<p><b>Russian (RU)</b></p> <p>Компания Cooler Master предоставляет на данное устройство ограниченную гарантию на оборудование сроком на два года, начиная от даты покупки. Сохраните кассовый чек для подтверждения покупки. Гарантия распространяется на нормальную эксплуатацию. Гарантия не распространяется на дефекты и повреждения, связанные с неправильной эксплуатацией, использованием не по назначению, происшествиями или небрежным обращением с изделием, и возникшие не по вине Cooler Master. Гарантия становится недействительной в случае удаления или изменения этикеток с номерами и обозначениями изделия и его деталей.</p> <ol style="list-style-type: none"> <li>В случае возникновения противоречий между гарантией, предоставленной в стране, в которой приобреталось изделие, и настоящим руководством, преимущественное значение имеет гарантия, выданная в месте покупки изделия.</li> <li>В случае неисправности электронных компонентов или необходимости приобретения принадлежностей в течение гарантийного периода обращайтесь в магазин, в котором было приобретено изделие.</li> </ol>
<p><b>Serbian (SR)</b></p> <p>Cooler Master obezbeđuje dve godine ograničene garancije na hardver za ovaj proizvod počevši od datuma kupovine. Sačuvajte račun kao dokaz o kupovini. Ponudena garancija pokriva normalnu upotrebu. Kvarovi ili oštećenja nastali usled nepravilnog rada, pogrešne upotrebe, zloupotrebe, nezgoda ili nemara prilikom korišćenja proizvoda, a koji nisu krivica kompanije Cooler Master, nisu pokriveni garancijom.</p> <p>Ova garancija se poništava u slučaju uklanjanja ili izmena proizvoda ili identifikacionih oznaka delova.</p> <ol style="list-style-type: none"> <li>U slučaju konflikta između garancije koja se daje u zemlji prodaje i ovog uputstva, garancija koja se daje u zemlji prodaje je dokument koji ima prednost.</li> <li>U slučaju kvara elektronskih komponenti ili potrebe kupovine delova tokom garantnog perioda, vratite proizvod na mesto gde je prvobitno bio kupljen.</li> </ol>	<p><b>Turkish (TR)</b></p> <p>Cooler Master, bu cihaz için, satın alma tarihinden itibaren başlanılan, iki yıllık süreli bir donanım garantisi sağlar. Lütfen faturanızı satın alma kurtu için saklayın. Sunulan garanti normal kullanım için kapsar. Hatallı kullanımdan kaynaklanan kusurlar veya hasarlar, yanlış kullanım, kötü kullanımlar, kazalar veya Cooler Master'in hatası olmayan ürünün ihmali garanti kapsamı dışındadır. Garanti, ürünlerin veya parçaların tanınmaları etiketlerinin kaldırılması veya değiştirilmesi ile geçersiz kılınır.</p> <ol style="list-style-type: none"> <li>Satış ülkesi tarafından verilen garanti ile bu kılavuz arasında bir anlaşmazlık olması durumunda, satış ülkesi garantisi geçerli olan belge olacaktır.</li> <li>Garanti süresi boyunca, elektronik parçaların arızalanması veya aksesuar satın alma gereksinimi olması durumunda, lütfen orijinal satın alma mağazasına geri dönün.</li> </ol>
<p><b>Ukrainian (UA)</b></p> <p>Cooler Master надає дворічну обмежену гарантію на апаратне забезпечення для цього пристрою, яка починає діяти з дати покупки. Зберігайте квитанцію для підтвердження покупки. Запропонована гарантія покриває нормальне використання. Дефекти чи пошкодження, які виникли внаслідок неправильної роботи, використання, порушення правил, нещасних випадків або недбалого поводження з виробом, які відбулися не з вини Cooler Master, не покриваються гарантією.</p> <p>Гарантія втрапить чинність у разі видалення чи заміни розпізнавальних етикеток виробів або деталей.</p> <ol style="list-style-type: none"> <li>У разі виникнення конфлікту між гарантією, наданою країною точки продажу, та цим посібником, переважачим документом є гарантія, надана країною точки продажу.</li> <li>У разі виникнення несправностей електронних деталей або необхідності придбання аксесуарів під час гарантійного періоду зверніться в магазин, де було придбано виріб.</li> </ol>	

Cooler Master Products: Limited Warranty  
This document describes the warranty terms for all Cooler Master product sold in Australia

**For Australia only:**  
Our goods come with guarantees that cannot be excluded under the Australian Consumer Law. You are entitled to a replacement or refund for a major failure and for compensation for any other reasonably foreseeable loss or damage. You are also entitled to have the goods repaired or replaced if the goods fail to be of acceptable quality and the failure does not amount to a major failure. Cooler Master Technology Inc. Telephone: +86-2-2225-3517 (standard international call charges apply).

**Who the Warranty Protects:**  
This Warranty is valid to the original purchaser only.

**What the warranty protects:**  
This warranty is valid only for the Cooler Master Products distributed by authorized dealer(s) in Australia. Please contact Cooler Master for warranty information and services.  
Cooler Master Support account: coolermaster.com

**What is and is Not Covered**  
It is important to note that our warranty is not an unconditional guarantee for the duration of the Program. Any replaced parts become the property of Cooler Master. The Program does not apply to the software component of a product or a product which has been damaged due to accident, misuse, abuse, improper installation, usage not in accordance with product specifications and instructions, natural or personal disaster, or unauthorized alterations, repairs or modifications. The Program does not cover any events such as below:  

- Any damages unrelated to manufacturing defects.
- Any unsuitable environment or use of the product in Cooler Master Opinion.
- Any product which has been modified without official permission from Cooler Master, or on which the serial number or warranty sticker has been defaced, modified, or removed.

**Damage, deterioration or malfunction resulting from:**  

- Accident, abuse, misuse, neglect, fire, water, lightning, or other acts of nature, commercial or industrial use, unauthorized product modification or failure to follow instructions included with the product.
- Third party products using Cooler Master Components will not be covered by warranty. See your vendor or the manufacturer for information about servicing.
- Repair or attempted repair by anyone not authorized by Cooler Master, Inc.
- Any shipment damages (claims must be made with the carrier).
- Unauthorized repairs to a Cooler Master product will void the warranty offered by the Program. Cooler Master reserves the right to refuse to service any product which has been altered, modified or repaired by non-Cooler Master Service personnel.
- Cooler Master does not warrant that this product will meet your requirements. It is your responsibility to determine the suitability of this product for your purpose.
- Removal or installation charges.
- You are responsible for the cost of shipping the product to Cooler Master. Cooler Master pays the cost of returning a product to you.
- Cooler Master reserves the right to replace the product with a service product at their sole discretion at any time.
- Product malfunction or damage resulting from liquids or moisture.
- All accessories that malfunction due to physical damage such as: USB cables, extension cables, adapter cables, adapters, power cords, screws, retention brackets, ear cups, and all other similar accessories.

**Limitation of Implied warranties:**  
THERE ARE NO WARRANTIES, EXPRESS OR IMPLIED, WHICH EXTEND BEYOND THE DESCRIPTION CONTAINED HEREIN INCLUDING THE IMPLIED WARRANTY OF MERCHANTABILITY AND FITNESS FOR A PARTICULAR PURPOSE.

**Exclusion of damages**  
COOLER MASTER'S LIABILITY IS LIMITED TO THE COST OF REPAIR OR REPLACEMENT OF THE PRODUCT. COOLER MASTER SHALL NOT BE LIABLE FOR:  

- DAMAGE TO OTHER PROPERTY CAUSED BY ANY DEFECT IN THE PRODUCT, DAMAGES BASED UPON INCONVENIENCE, LOSS OF USE OF THE PRODUCT, LOSS OF TIME, LOSS OF PROFITS, LOSS OF BUSINESS OPPORTUNITY, LOSS OF GOODWILL, INTERFERENCE WITH BUSINESS RELATIONSHIPS OR OTHER COMMERCIAL LOSS, EVEN IF ADVISED OF THEIR POSSIBILITY OF SUCH DAMAGES.
- ANY OTHER DAMAGES, WHETHER INCIDENTAL, CONSEQUENTIAL OR OTHERWISE
- ANY CLAIM AGAINST THE CUSTOMER BY ANY OTHER PARTY

**Warranty Information:**  
If the goods is found with reasonable defect within the period of (refer to Table A,) starting on the first day of purchase (with proof of invoice), this is what you must do, to claim the warranty from the above address.

**Procedures:**  

- Consumers should return to the shop where he/she has bought the goods. After confirming with the shop with a valid invoice, they may approach the distributor for RMA claim.
- After confirmed by the distributor that the goods was damaged due to natural causes, replacement and repair will be done by distributor (including brand new or refurbished goods)
- All faulty goods must return to the distributor, expenses for returning the faulty goods will be covered by the consumer, and distributor will cover the cost involved in the transporting of parts or repaired goods to the consumer.

Regarding all the expenses incurred in making the claim, and this is how you would claim:

- Within the valid warranty date, starting from the first day of issuing invoice, Retail shops will assist in confirmation with distributor for the consumer for the following.
  - If the damage was caused by the consumer, then the consumer should cover all expenses in fixing the product, if the product still can't be fixed, we would suggest consumer in buying a brand new product.
  - Product defect caused under natural use, expenses will be covered by the distributor.
- Faulty products with expired warranty dates, we would suggest consumer to purchase a brand new products, without undergoing for repairs.

For more warranty information, please visit our official website: <http://www.coolermaster.com/service/warranty.html>



**Make It Yours.**

