

1

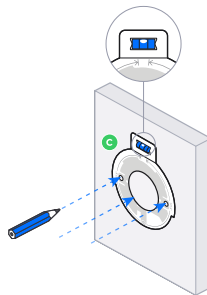

2

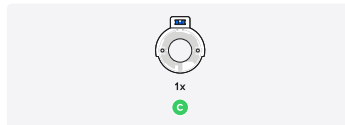
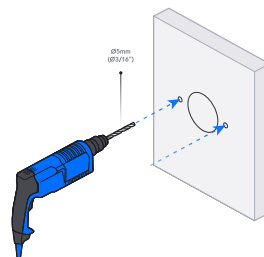

3

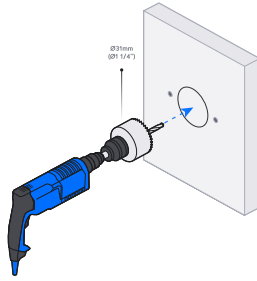

4

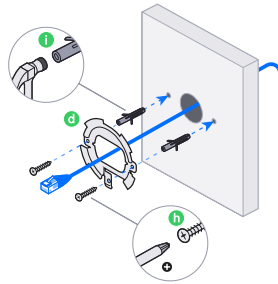
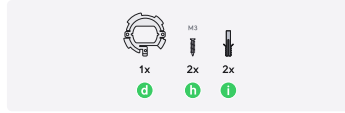

5

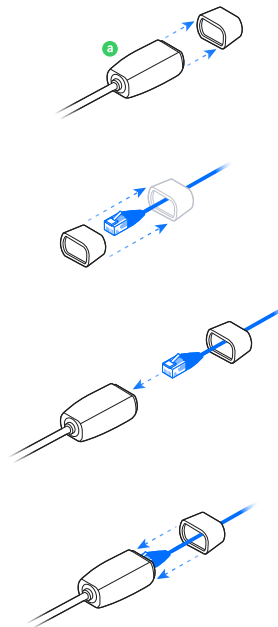
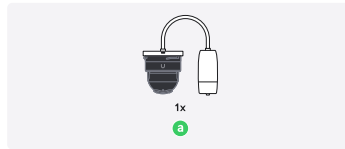

6

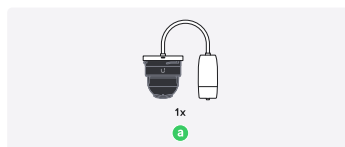

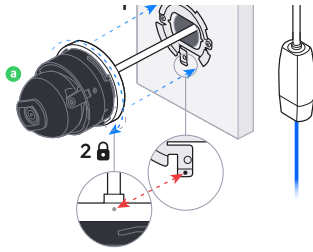

# 7

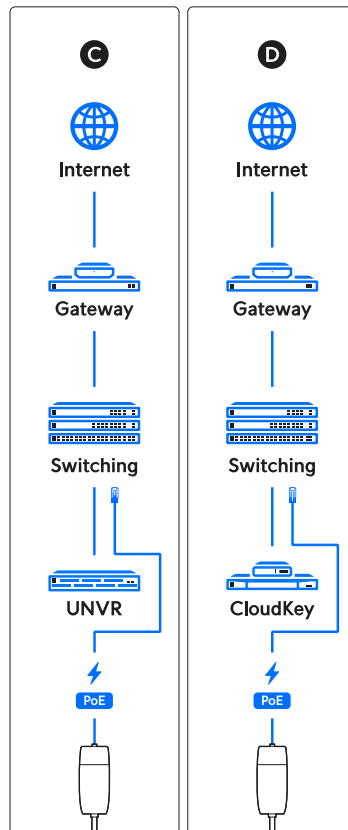
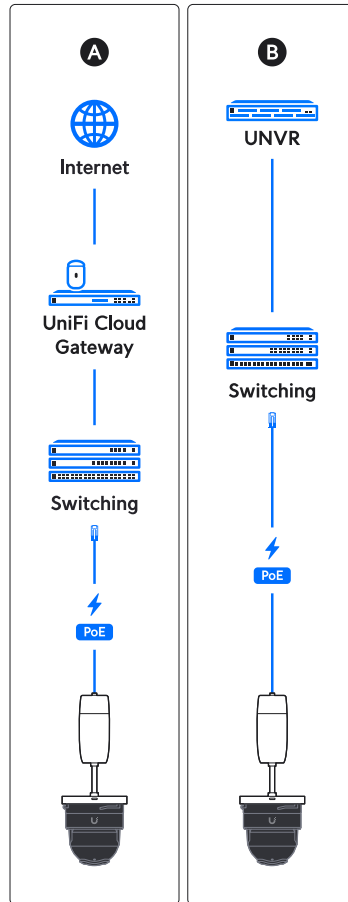

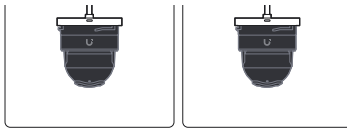

8



9

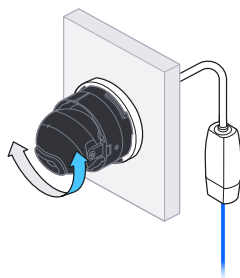
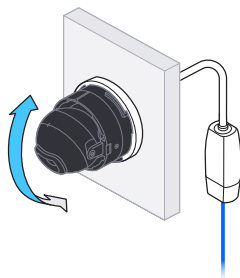
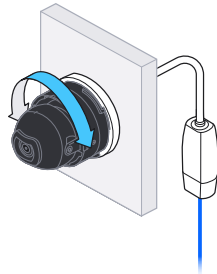

10

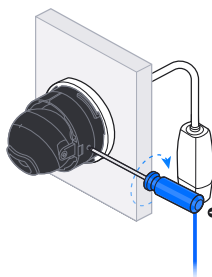

11



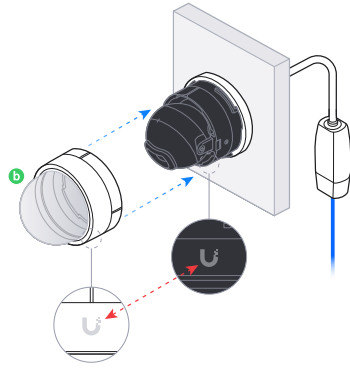

12

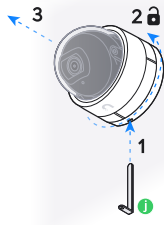
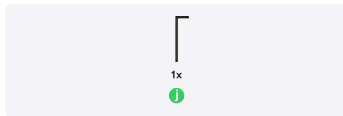
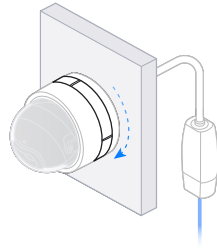

If you need further assistance, visit our [Help Center](#) or contact [Ubiquiti Support](#).

©2018 Ubiquiti Networks, Inc. All rights reserved. Ubiquiti, the Ubiquiti logo, and UniFi are trademarks or registered trademarks of Ubiquiti Networks, Inc. or its affiliates. UniFi is a service mark of Ubiquiti Networks, Inc. All other trademarks are the property of their respective owners. Ubiquiti Networks, Inc. is not responsible for any damage to your equipment or data that may result from the use of this product. Ubiquiti Networks, Inc. is not responsible for any damage to your equipment or data that may result from the use of this product.