



**Elo Touch Solutions**  
IDS 3204L/4304L/5054L/5554L/6554L Display



**Copyright © 2024 Elo Touch Solutions, Inc. All Rights Reserved.**

No part of this publication may be reproduced, transmitted, transcribed, stored in a retrieval system, or translated into any language or computer language, in any form or by any means, including, but not limited to, electronic, magnetic, optical, chemical, manual, or otherwise without prior written permission of Elo Touch Solutions, Inc.

**Disclaimer**

The information in this document is subject to change without notice. Elo Touch Solutions, Inc. and its Affiliates (collectively “Elo”) make no representations or warranties with respect to the contents herein, and specifically disclaims any implied warranties of merchantability or fitness for a particular purpose. Elo reserves the right to revise this publication and to make changes from time to time in the content hereof without obligation of Elo to notify any person of such revisions or changes.

**Trademark Acknowledgments**

Elo, Elo (logo), Elo Touch, Elo Touch Solutions, and EloView are trademarks of Elo and its Affiliates.

**Revise Note**

REV	Change list
A	Initial Release
B	Add Crestron Cloud Service Supported guide
C	Add Local LAN (TCP/IP) MDC support guide (2025/03/28)
D	Update Active pen support models.

# Table of Contents

Section 1: Introduction ..... 4

Section 2: Unpacking ..... 5

Section 3: IDS Display Installation ..... 7

Section 4: Mounting Information ..... 18

Section 5: Operation ..... 21

Section 6: Maintenance Information ..... 36

Section 7: Technical Support ..... 37

Section 8: Regulatory Information..... 38

Section 9: Warranty Information..... 43

Section 10: Appendix A..... 44

# Section 1: Introduction

## Product Description

Your new Interactive Digital Signage (IDS) Display combines Elo Touch Solutions reliable performance with the latest developments in touchscreen technology and display design. This combination of features creates a natural flow of information between a user and the IDS Display.

This IDS Display incorporates 8-bit color (ET3204L and ET4304L) and 8-bit+FRC (5054L/5554L/6554L), active matrix thin-film-transistor, and digital signage LCD panel to provide superior display performance. ET3204L and ET4304L output FHD resolution (1920 x1080) and ET5054L/ET5554L/ET6554L output 4K resolution (3840 x2160) are suitable for displaying graphics and images. Other features that enhance this LCD monitor's performance are Plug & Play compatibility, built-in speakers and headphone output capability, Touch On-Screen Display (OSD) controls, and a family of Elo backpack modules.

## Precautions

- Follow all warnings, precautions and maintenance as recommended in this user manual to maximize the life of your unit and prevent risks to user safety.
- For your health and safety, it is strongly recommended that at least two people handle, lift, and/or move these IDS Displays.
- This manual contains information important for the proper setup and maintenance of the IDS monitor. Before setting up and powering on your new IDS Display, read this manual, especially the Installation, Mounting, and Operation chapters.
- CAUTION: Risk of Explosion if Battery is replaced by an Incorrect Type. Dispose of Used Batteries According to the Instructions.

# Section 2: Unpacking

## Unpacking the Interactive Digital Signage (IDS) Display

To unpack the IDS, follow these steps:

1. The carton should be oriented in the manner according to its labeling. The hinged plastic locks should be at the 'bottom'.
2. Unlock and remove all 4-6 hinged plastic locks.
3. Once the locks are removed, lift the cartons top lid off the bottom frame.

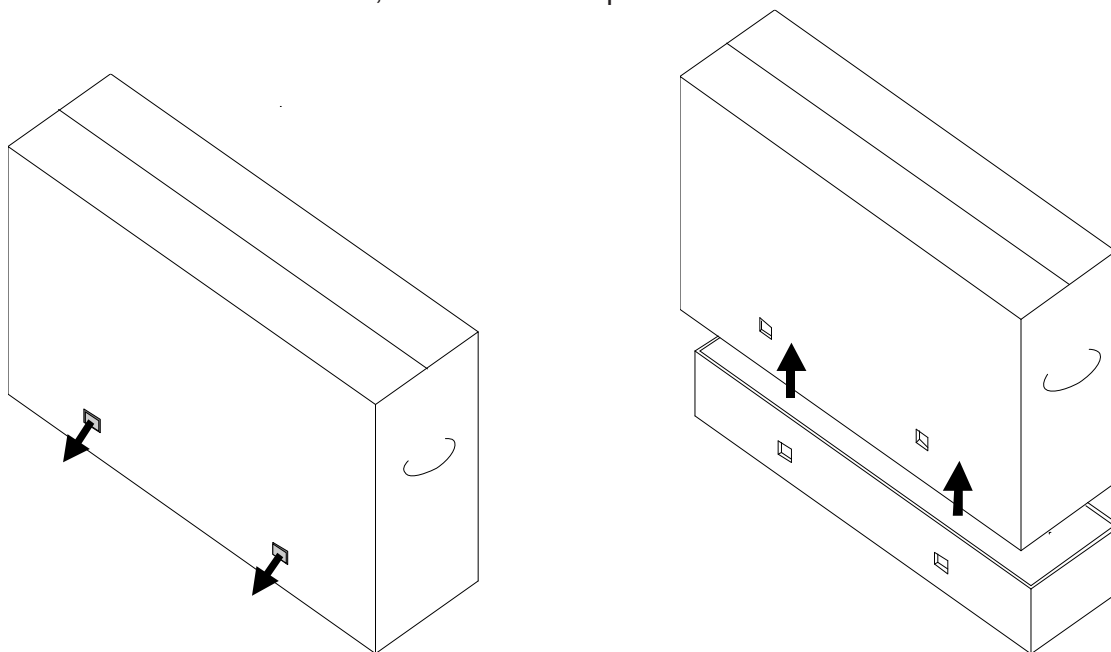

4. With the top lid removed, you now have access to the IDS Display and the accessories box.

Verify that the box contains:

- IDS ET3204L/ET4304L/ET5054L/ET5554L/ET6554L IDS Display
- Quick Install Guide
- ACIN Power cable, IEC 60320-C13 to NA plug.
- ACIN Power cable, IEC 60320-C13 to EU/KR plug.
- ACIN Power cable, IEC 60320-C13 to UK plug.
- ACOUT Power cable, IEC 60320-C14 to IEC 60320-C5 (0.3m)
- USB cable (Type C plug to Type C plug, 1.0m)
- Energy label according to EU Regulation 2019/2013, EU EEI x1 pcs, UK EEI x 2pcs
- M4x6mm flat head screws x 4pcs in zipped PE bag

# Section 3: IDS Display Installation

## IDS Display: Connecting to an External Computer

1. Connect inbox touch cable (USB-C to USB-C) between the IDS Display and the host PC.  
NOTE: IDS Display USB-C port only supports USB2.0 plus video input. Power Delivery and USB3.0 not supported.
2. Connect a video signal cable (HDMI or DisplayPort) if the host PC does not support USB-C video out.
3. Connect power cord to AC wall socket to the IDS rear AC power input connector.  
The monitor will turn on while first time AC power detected.
4. Side buttons on rear side including Power, OSD menu, and Video Select buttons. They are located on bottom right side.

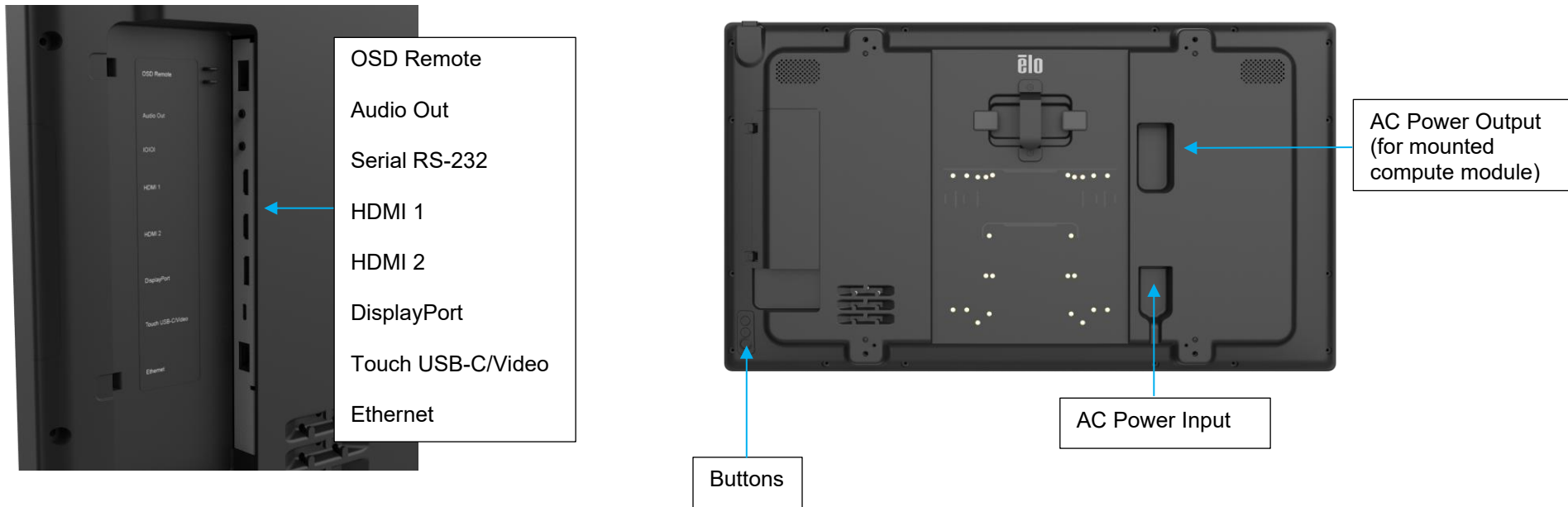

## IDS Display: External Computer mounting and power connection

1. Install external computer on backside of IDS (100mm VESA pattern) and secure with M4 flat-head screws.
2. Secure the power supply with the Velcro straps.  
(Excess power supply cable can be stored in the recess under the power supply.)
3. IDSx4 provide AC bypass power C14 socket. Using inbox short cable (C14 to C5) connects Power supply with IDS.

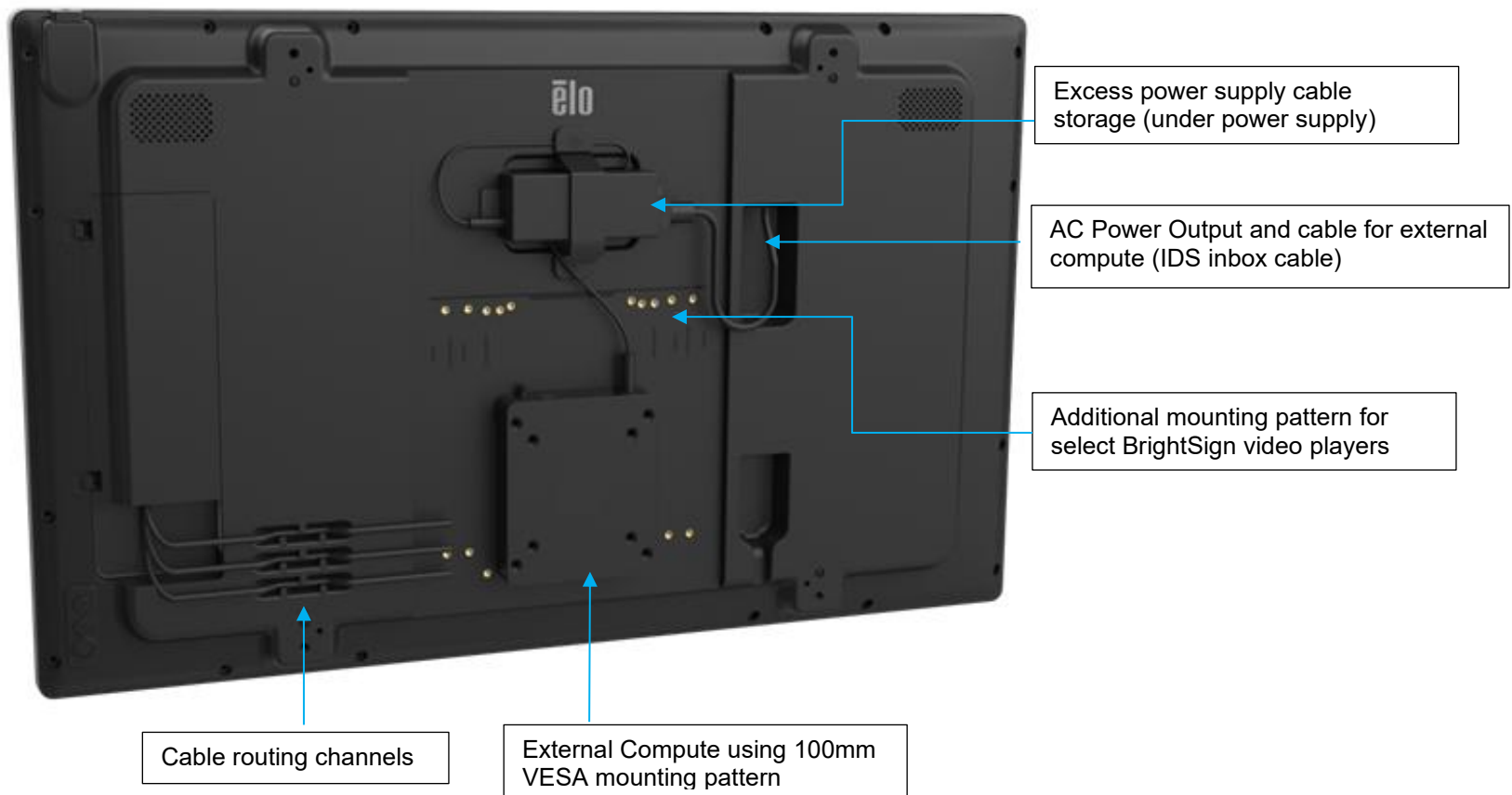

## IDS Display: Connecting to other Operating Systems

Visit the Elo Touch Solutions website [www.elotouch.com](http://www.elotouch.com) for:

- Updates to the monitor firmware
- Detailed driver installation guides
- Touch drivers for other operating systems
- Mac OS Driver (UPDD) does not support Wake on Touch function when Mac OS device connected.
- When connecting with [MacOS system](#), please install the [Multi-Touch Driver](#) for macOS.

### Drivers, Files & SDK Downloads

Welcome to our download tool. By downloading a driver, you agree to the terms and conditions of the applicable End User License Agreement (EULA) on behalf of yourself and the company you represent. View the applicable EULA by clicking on the EULA link in the Notes. Choose a category to begin:

Touch Drivers   macOS   Current   Single & Multi Touch

Driver Download	Version	Supported Technologies	Notes
<a href="#">MultiTouch Driver for macOS</a>	6.0	TouchPro® (PCAP), IntelliTouch® (SAW), IntelliTouch® Plus (eSAW), AccuTouch® (Resistive), CarrollTouch® (IR), iTouch/iTouch Plus, Surface Capacitive, Optical	Version 6.0.x is for Mac OS 10.8 and above. Mac OS driver only supports single touch when used on iTouch Plus and IntelliTouch® Plus products. <a href="#">Download macOS touch drivers</a> <a href="#">Installation Guide</a> <a href="#">EULA</a>

TouchPro and Infrared units are HID compatible and do not require an Elo touch driver. If an Elo touch driver has previously been installed on the host computer, remove this driver by opening the Control Panel and selecting the option to remove the driver completely.

## IDS Display: Connecting Wi-Fi adapter

- The USB-A port on top-right edge is Elo Wi-Fi adapter supporting only.
- Elo optional WIFI Adapter IDS04/54 (E131942) supports WPA/WPA2 encryption support and 2.4GHz / 5GHz frequency band.
- LAN cable is priority, please disconnect LAN cable after Wi-Fi SSID setting done. E.g. the connection will auto switch from LAN to Wi-Fi in minutes while LAN cable unplugged, reconnection time will be depending on Wi-Fi router performance.
- Please check IoT connectivity section or QIG590425 for Wi-Fi SSID and IoT setup.



**Caution:** Remove AC power to the IDSX4 Display before installing/un-installing Wi-Fi adapter or LAN cable

## IDSx4 IoT connectivity for device control and monitoring

IDS04 and 54 series signage can support EloView or Crestron cloud service when internet connected.

Visit IDS local webpage for cloud service switching and optional Wi-Fi adapter kit setting.

- EloView: Elo Cloud control supported.
- Crestron: CCV2 supported and is compatible with the Crestron XiO Cloud “Service”

**\*IoT will be disconnected when system in sleep mode and off mode.**

**\*Disable “Energy saving mode” in OSD menu or EloView setting to keep IoT online when system sleep.**

**CRESTRON**  
CONNECTED

IDS IoT Guide

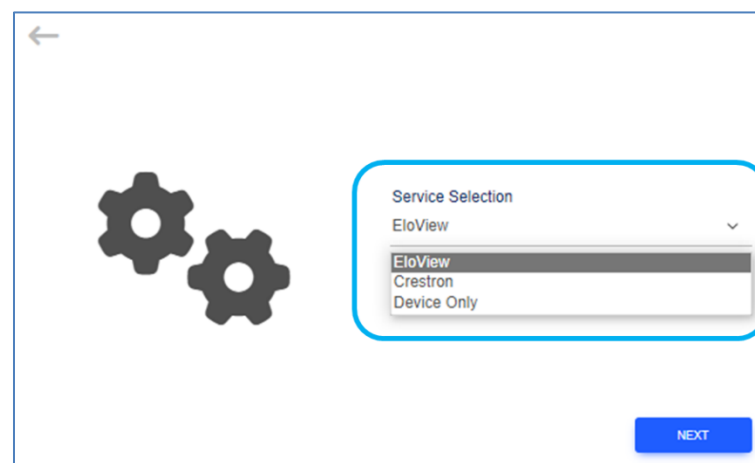
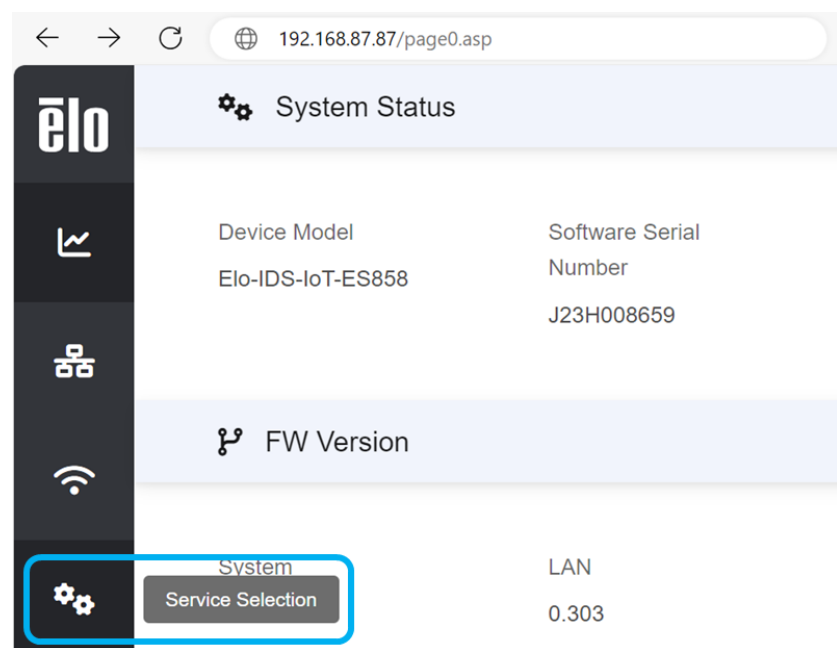

## Login to IDSx4 Local webpage

Method 1- **DHCP assigned IP**, Connect IDS LAN port to the router which PC also connected with.

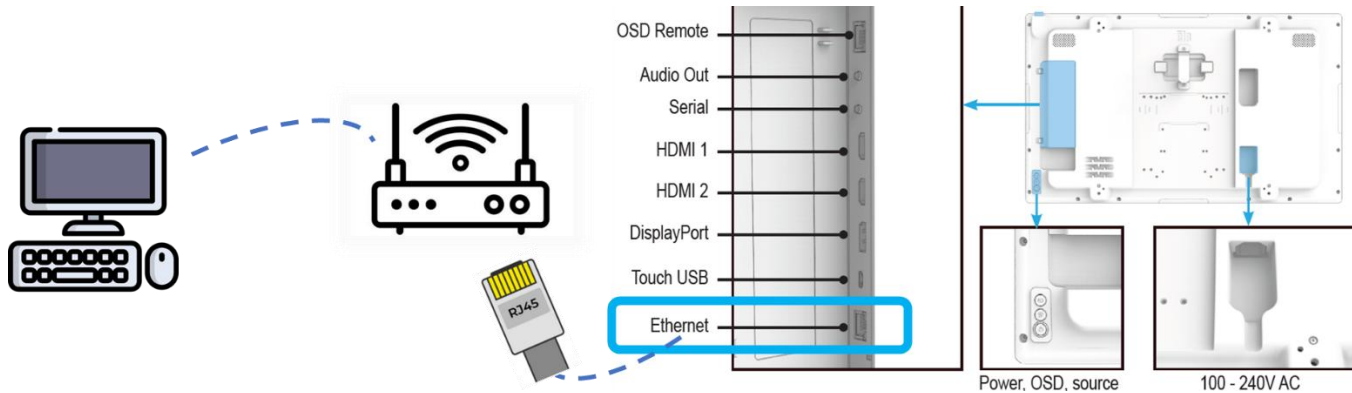

- ✓ Check Information page 2 in OSD menu (Click “→” in information page)
- ✓ Open PC web browser and key in the assigned IP (ex. 192.168.001.166)

The screenshot shows the Elo OSD menu with the 'Information' option highlighted. The 'IP Setup' screen is displayed, showing the IP address 192.168.1.166. The 'Network Status' page shows the device is online with the IP address 192.168.001.166. The system temperature is 38 °C / 100 °F. The error message is 'Check on EloView Website'.

**Caution:**  
iOS Safari and Android browser may display IDSx4 Local Webpage with wrong resolution.

Method 2- **Static IP**, Connect LAN Cable between IDSx4 and PC (RJ45 LAN port). System set up:

- IDSx4 device
- LAN Cable (RJ45)
- PC (Windows/Linux/MacOS), Ethernet setting check required to link IDS static IP (192.168.87.87)  
(Ethernet Properties→ TCP/IPv4 → set PC's static IP address: 192.162.87.X (X=1~255), Subnet mask: 255.255.0.0)

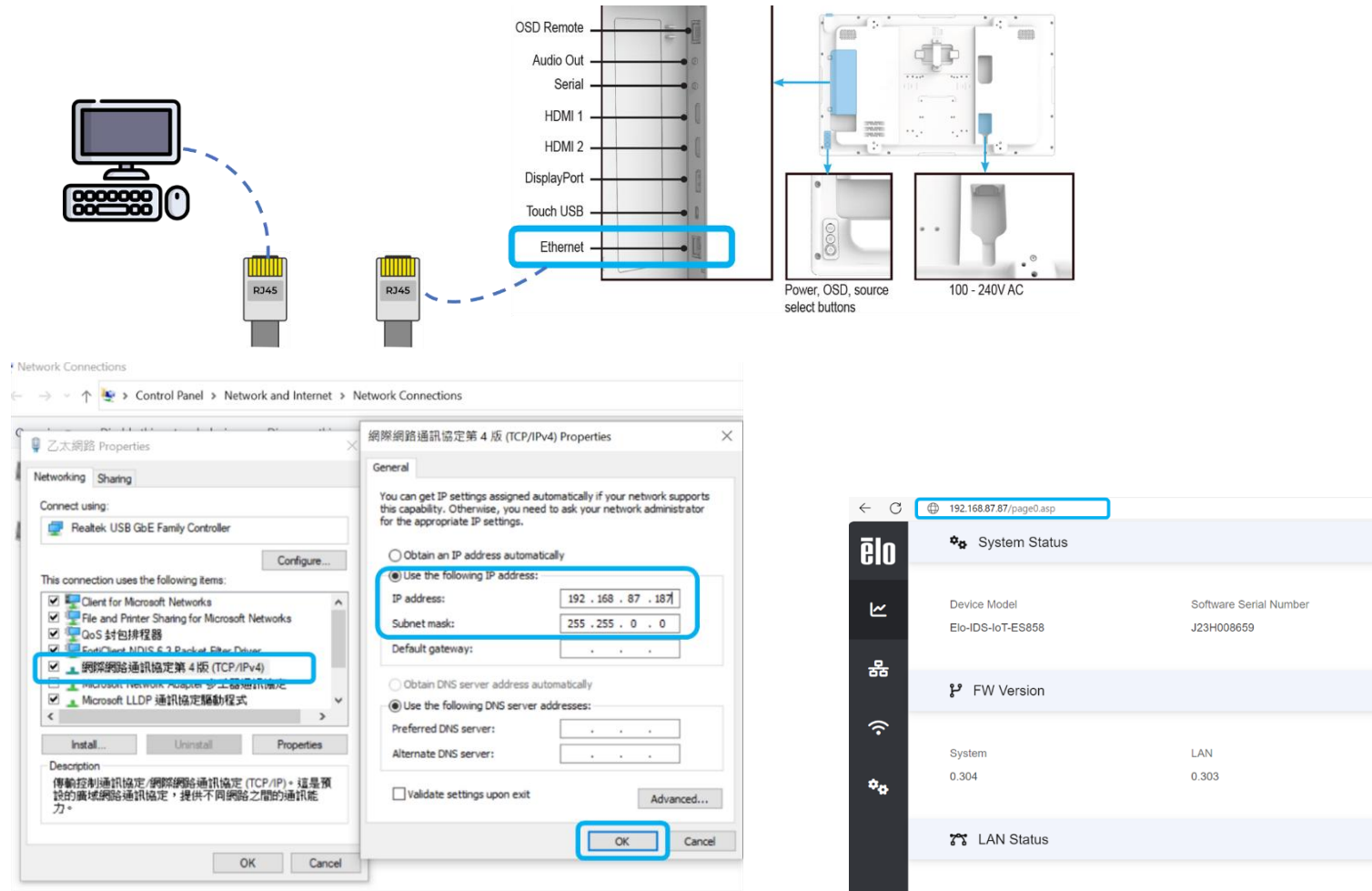

## Wi-Fi adaptor setting Local webpage

- Click “Wireless Setup” icon on IDSx4 local webpage side bar
- Click “SCAN NETWORK” button to select Wi-Fi SSD (Figure Left); Select SSID and click CONNECT button (Figure Right)

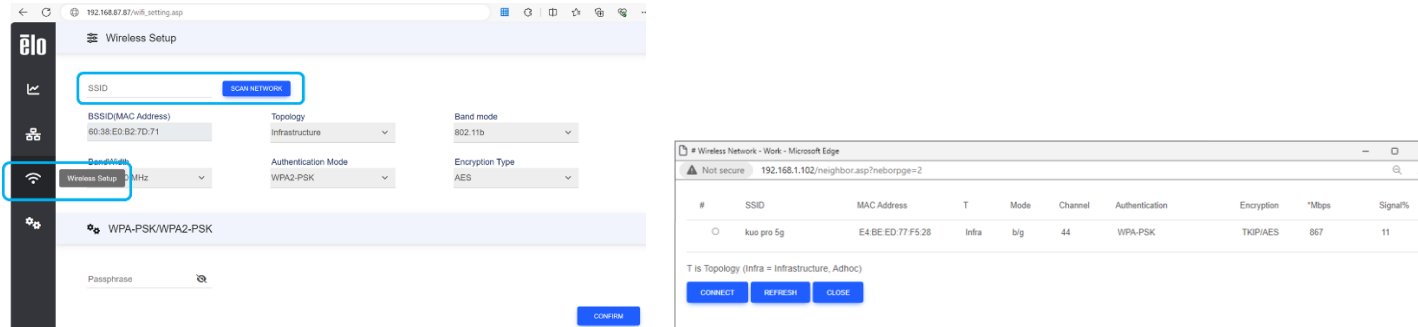

- Key-in Passphrase and click CONFIRM to start Wi-Fi connecting (Figure Left); Check WLAN IP in Info page (Figure Right)

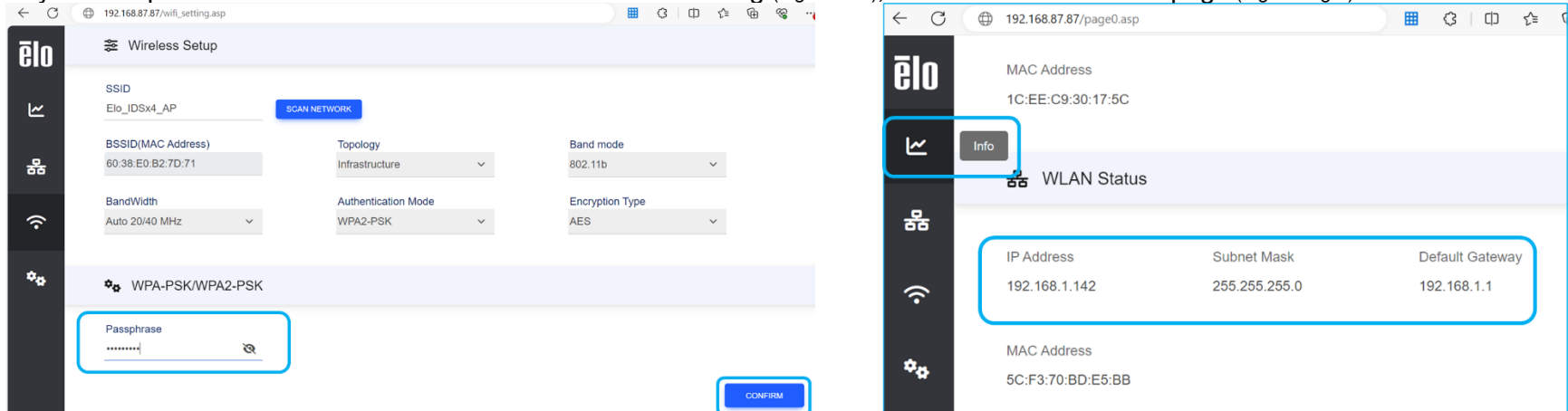

## System FW update (OTA)

- Power on IDS, press side button to open the On-Screen-Display Menu.
- Click Radio Button “FW Update (OTA)” in Configuration page.
- **DO NOT TURN OFF POWER OR UNPLUG AC POWER CORD DURING FW UPDATE**



Menu button

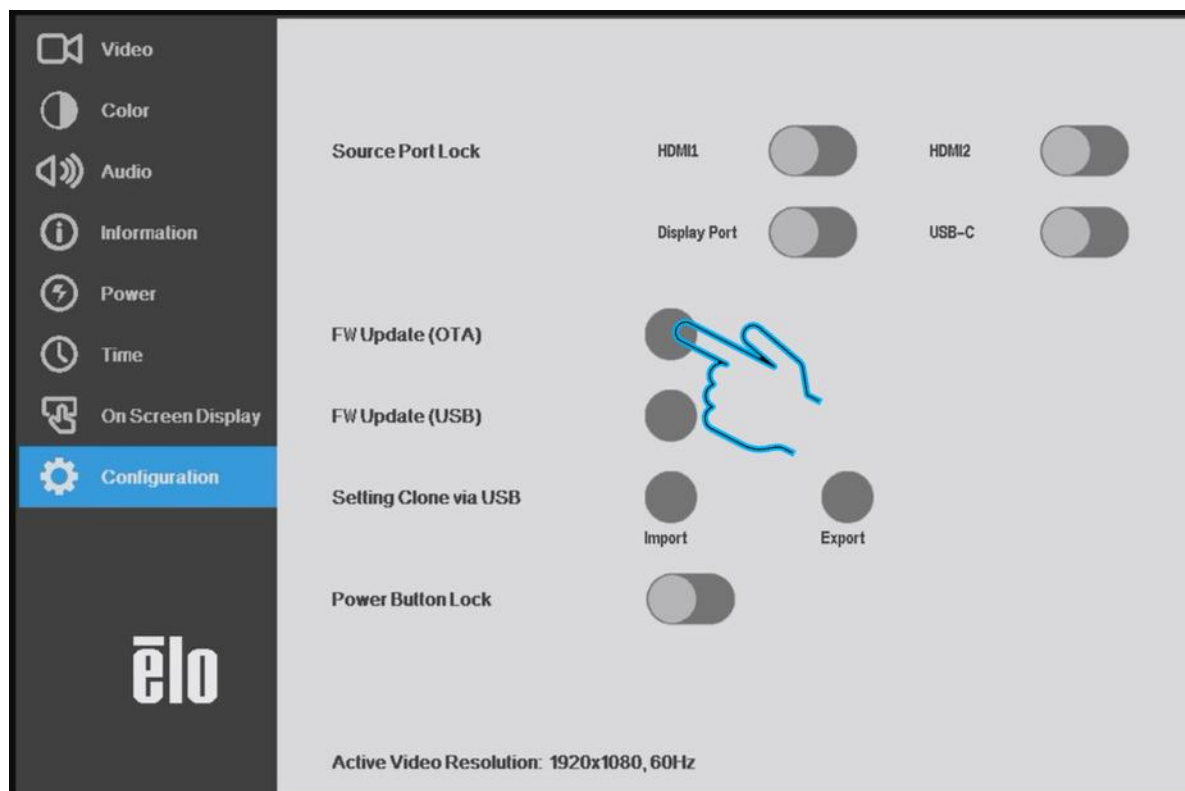

- Message box will appear around 8 minutes until FW upgrade completed. After FW update complete, IDS will reboot automatically.

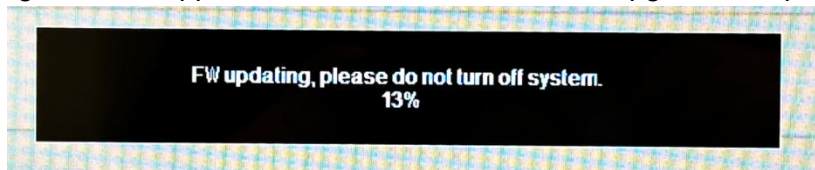

# System FW update (USB)

- Download IDSx4 FW Package from [Downloads | Elo® Official Website \(elotouch.com\)](https://www.elotouch.com) and store FW package (.pkg) into USB flash

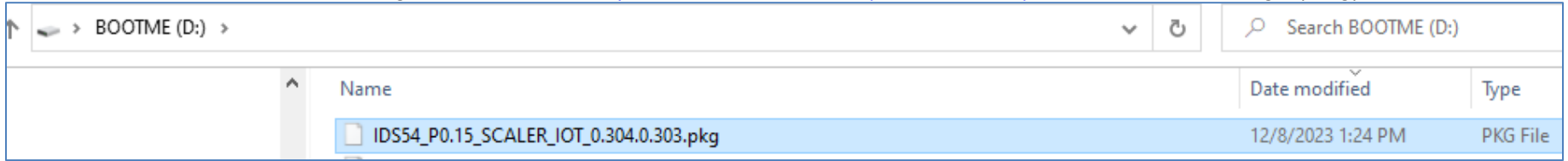

- Connect the USB stick / USB drive with .pkg file (format in FAT32 file system is required).

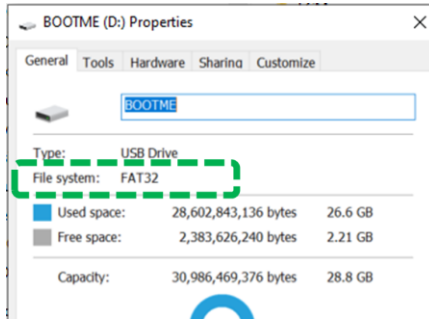

- Go to Configuration page, Click Radio Button “FW Update (USB)” in OSD menu
- Message box will appear around 5minutes until FW upgrade completed. After FW update complete, IDS will reboot automatically.

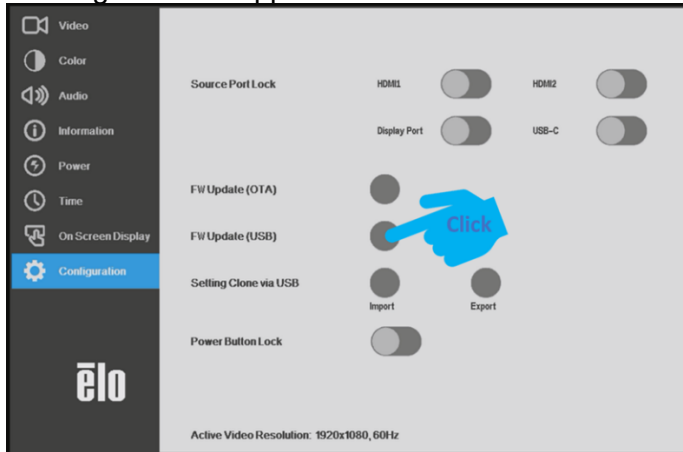

## Check FW version and Update Result

- ✓ After Package FW update complete, IDS will reboot automatically.
- ✓ Check Information page in OSD menu, Firmware Version will be updated accordingly.
  - \*\*IoT FW will delay 1 minute to show up. (Display X.XXX when initial power on)

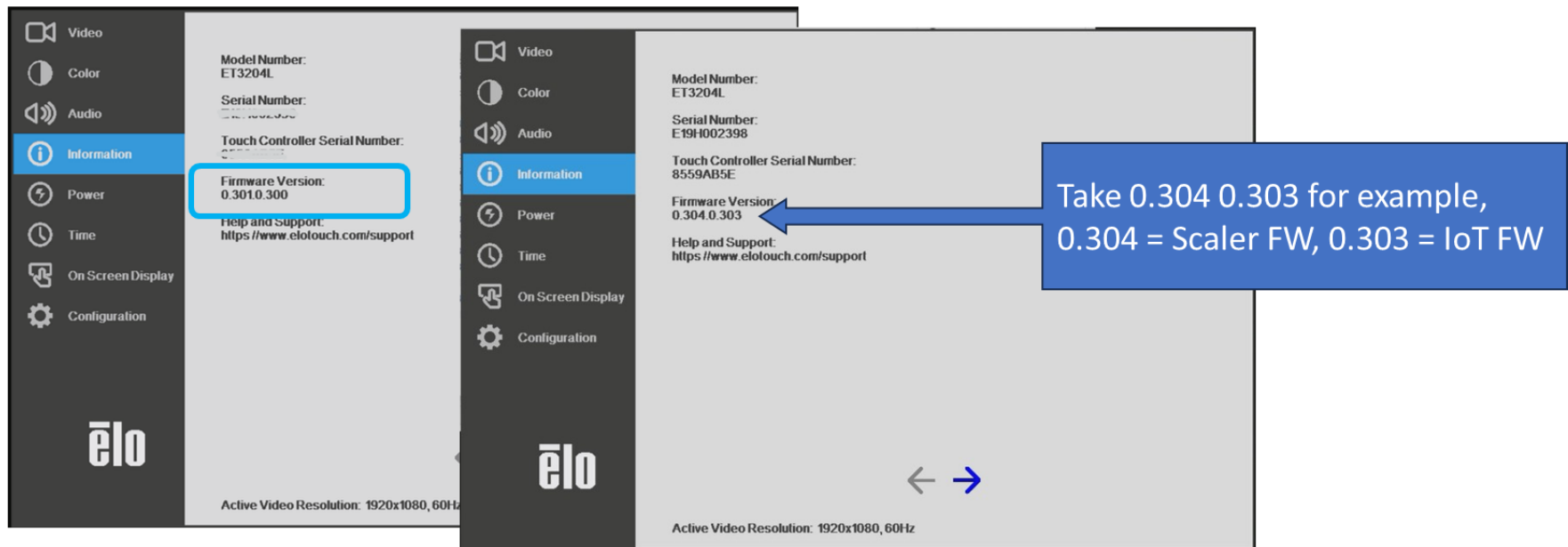



# Section 4: Mounting Information

Note: It is strongly recommended that at least two people handle, lift, or move the IDS Display. Do not leave the IDS Display facing down for extended periods of time as this will cause permanent damage to the LCD panel.

## Mounting Orientations

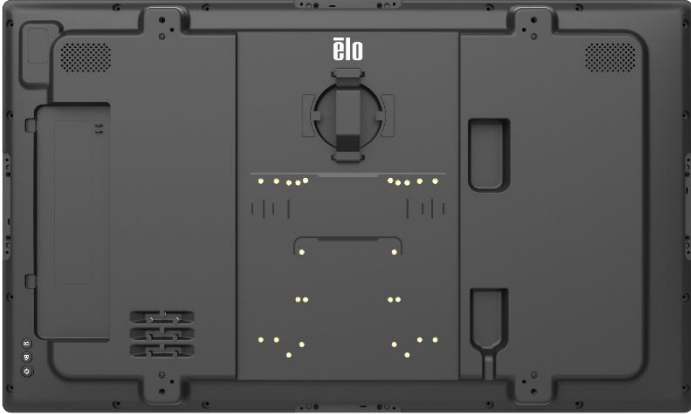
The following mounting orientations are supported: landscape, portrait, tabletop, and tilt.

<p><b><u>Landscape</u></b></p> 	<p><b><u>Portrait</u></b></p> <p>Note: When rotating the IDS Display to portrait orientation, Elo recommends orienting the IO ports at the bottom to accommodate ease of cable connection when wall mounting.</p> 
--	--

### **Tabletop (Screen facing upward)**

Note: When the IDS Display is used in tabletop application, support the IDS Display using the VESA mounting pattern on the rear to support the weight of the IDS Display. Additional support around the edge may also be required to maintain flatness of the touch screen. Cooling methods must be put in place to ensure that the air temperature beneath the monitor does not exceed the operating specifications. Refer to the Operating & Storage Conditions section for tabletop mode requirements.



### **Tilt**

Note: The IDS Display can be tilted forward a maximum of 15 degrees.



## **Caution: Stability Hazard**

***The device may fall, causing serious personal injury or death. To prevent injury, this device must be securely attached to the floor/wall in accordance with the installation instructions.***

## Rear VESA Mount

A four-hole, VESA mounting pattern is provided on the rear of the IDS Display. The VESA FDMI-compliant mounting is coded:

- **ET3204L** : MIS-F, 400, Y, 6mm x 18mm (4 screws M6x15mm)
- **ET4304L** : MIS-F, 400, Y, 6mm x 25mm (4 screws M6x15mm)
- **ET5054L** : MIS-F, 400, Y, 6mm x 23mm (4 screws M6x15mm)
- **ET5554L** : MIS-F, 400, Y, 6mm x 25mm (4 screws M6x15mm)
- **ET6554L** : MIS-F, 600, Y, 8mm x 18mm (4 screws M6x15mm)

Refer to [www.elotouch.com](http://www.elotouch.com) for dimensional drawings.

## Optional Mounting Methods

An optional stand kit and low-profile wall-mount kit are available for the IDS ET3204L/ET4304L/ET5054L/ET5554L/ET6554L Displays. Detailed information is available on the marketing specification drawing at [www.elotouch.com](http://www.elotouch.com). Consult each kits user guide for detailed installation information.

### **Elo Stand kit:**

Elo Part Number: E722153, Includes mounting screws M6x20mm (x4), and M6x55mm (x4)

Drawing Numbers: MS603258 / MS603259 / MS603260 for IDS ET3204L/ET4304L/ET5054L

### **Elo Low Profile Wall Mount kit:**

Elo Part Number: E721949, Includes mounting screws M4x10mm (x2), M6x15mm (x4)

Drawing Numbers: MS602351/ MS602352/ MS602353 for IDS ET3204L/ET4304L/ET5054L

### **Elo Low Profile Wall Mount kit:**

Elo Part Number: E727774, Includes mounting screws M4x16mm (x2), M8x25mm (x4) and M8x40mm (x4)

Drawing Numbers: MS603261 / MS603262 for IDS ET5554L/ET6554L

# Section 5: Operation

## Power

To turn the IDS On or Off, press the power button once.

The system consumes low power when in SLEEP and OFF modes. For detailed power consumption specifications, refer to technical specifications available on the Elo website [www.elotouch.com](http://www.elotouch.com). Touching the screen will bring the system out of MONITOR SLEEP mode. If extended periods of disuse are planned, unplug the AC power cable to save power. The maximum voltage, frequency, and current for the IDS Display are provided in the power ratings table below:

Operating Voltage Range	Operating Frequency Range
100 - 240Vac	50/60 Hz

## Usage Duty Cycle

To save energy and extend the life of the display, Elo recommends shutting off the display when not in use. Several tools such as Content Management System (CMS) player applications, Operating System settings, and the Real Time Clock feature on the On-Screen Display Menu (OSD) within the IDS display can be used for this task.

## Touch Technology

When connected to Windows 10 or 11 computer, the IDS Display will report the corresponding simultaneous touches:

TouchPro supports up to 40 touches.

Infrared supports up to 20 touches.

The IDS Display product specification can be found by visiting <https://www.elotouch.com/>

## Video Information

The LCD panel native resolution is its width and height measured in number of pixels. In most cases, an image displayed on an LCD monitor will look best when your computer output resolution matches the LCD panel native resolution. See the display specifications on the Elo website [www.elotouch.com](http://www.elotouch.com) to find your IDS Displays native resolution. Operating in other resolutions will degrade video performance and is not recommended.

For computer output resolutions at non-native resolutions, the monitor will scale the video to panel's native resolution. For smaller input video resolutions, this involves "stretching" the input image in the X- and Y-dimensions to fit the panel. For larger input video resolutions, this involves "compressing" the input image in the X- and Y-dimensions to fit the panel. An unavoidable byproduct of the scaling algorithms is a loss of fidelity when the computers output video image is scaled by the monitor to fit the display. This loss of fidelity is most apparent when viewing feature-rich images at close distances (for example images containing small-font text). Your IDS Display will not usually require any video adjustments.

## Touch On-Screen Display (OSD)

This monitor uses an easy-to-navigate Touch OSD interface. Use the settings menu in the sidebar to adjust the IDS Display settings

### Example of the Popup OSD Menu:

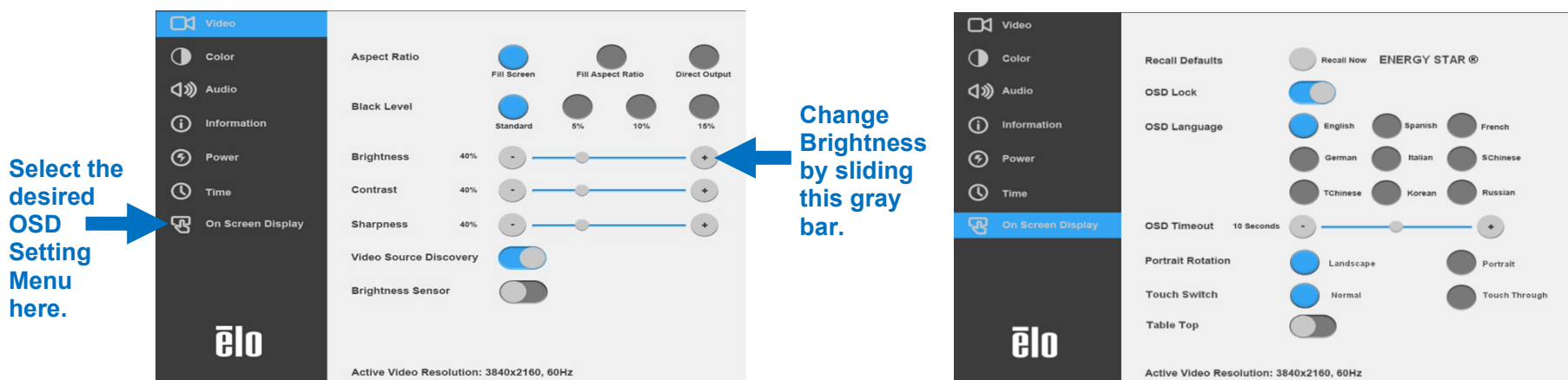

All IDS Display adjustments made through the OSD are automatically stored as soon as they are entered. This feature saves you from having to reset your choices every time the IDS Display is unplugged or powered off and on or if there is a power failure.

	Parameter	Available Adjustment
<b>On Boot Up</b>	<b>Let's Get Started</b>	On first boot up, the Language, Time and Time Zone must be selected
<b>Video</b>	<b>Aspect Ratio</b>	Adjusts aspect ratio of the display. Default: Fill Screen <b>Fill Screen:</b> scales the X- and Y-dimensions of the input video (up or down as needed) to the display's native resolution. <b>Fill Aspect Ratio:</b> Assuming a landscape orientation and an input video with aspect ratio smaller than 16:9, scales the Y-dimension of the input video (up or down as needed) to the display's Y-resolution, and scales the X-dimension to maintain the aspect ratio (and fills the rest of the display with equal black bars on the left and right). <b>Direct Output:</b> 1:1, Depends on whether the scalar can support it
	<b>Black Level</b>	The user can choose between Standard, 5%, 10% or 15% black level offset. The saturation level of the colors change according to the chosen black level offset.
	<b>Brightness</b>	Adjust the brightness of the display.
	<b>Contrast</b>	Adjust the contrast of the display. Default: 50
	<b>Sharpness</b>	Adjusts sharpness of the displayed images. Default: no sharpness adjustment Sharpness function is disabled when the input source ratio is the same as the panel's native ratio
	<b>Video Port Discovery</b>	When enabled, the monitor will automatically switch if a new video port is connected. Default: Enabled
	<b>Brightness Sensor</b>	The light sensor can be toggled on or off. When the light sensor is enabled, the brightness cannot be changed manually. Table for light sensor is in Section 10: Appendix A

	Parameter	Available Adjustment
<b>Color</b>	<b>Color Temperature</b>	Adjusts color temperature. Color temperature options shall be 9300K, 7500K, 6500K, 5500K, 3200K and User Defined. Default: User Defined
	<b>User Preset</b>	If the User Preset option is selected, the user can change the color temperature by changing individual R, G, and B gains on a scale from 0 to 100.
	<b>Picture Mode</b>	Preset color modes that change the color parameters to enhance color definitions. Available modes are: Standard, Movie, Gaming, Photo, Line mode, Color Enhance Default: Standard
	<b>Color Sensor</b>	Adjusts the display's color based on ambient color Temperature reading.
	<b>HDMI Full Color Range</b>	When enabled, displays full color range of HDMI (0-255) When disabled, displays the legacy color range (16-255) Default: enabled

	Parameter	Available Adjustment
<b>Audio</b>	<b>Mute</b>	Enables or disables the audio Default Off
	<b>Volume</b>	Adjust the audio from 0 – 100 Default: 50
	<b>Audio Output</b>	Sets where audio output is sent: When set to Speaker, audio is sent to the IDS Display speakers When set to Line Out, audio is sent to the <i>audio out</i> port on the IDS Display

	Parameter	Available Adjustment
Information (Two pages)	Monitor info	[Model Model: "Model Number: XYZ"] [Monitor SN: "Serial Number: XYZ"] [Touch Controller SN: "Touch Controller Serial Number: XYZ"] [Firmware Revision: "Firmware Version: W.XYZ.A.BCD"] -> Scaler version: W.XYZ, IoT version: A.BCD
	IoT Ability	Internet Connection: "Network Status: Offline/Online" [IP: xxx.xxx.xxx.xxx] IP address in black color means LAN cable connection IP address in blue color means Wi-Fi connection
	Temperature	[System temperature: Fahrenheit: /Celsius]
	Error	[Error log notification: Error Message: Null/Check on EloView Website]

	Parameter	Available Adjustment
Power	Wake on Touch	Enable or disable the Touch USB port wake function Default: Enabled
	Energy Savings Mode	When enabled, the monitor must adhere to Energy Star regulations Default: Enabled
	Power Status Light	Enable or disable the power status light Default: Enabled
	Power Loss Behavior	Select device behavior after AC power loss [Last State/ Always On/ Always Off] Default: Last State
	Auto Display Wake Up	When enabled, the light sensor can be used to wake the monitor from sleep mode Default: Enabled
	HDMI CEC	Enable/Disable HDMI CEC control
	Wake on IoT	Enable/Disable Wake on IoT (EloView command) via touch USB (PCAP only)

	Parameter	Available Adjustment
Time	Time Set	Option to set the current time
	On/Off Schedule	Set the monitor to turn off and on at specific times. Default: Everyday Off: 01:00:00 On: 07:00:00

	Parameter	Available Adjustment
On Screen Display	Recall Defaults	Selecting “Recall Defaults” restores all factory default settings for OSD-adjustable parameters (except OSD Language and OSD Time Settings) and for Preset Video Mode timings. *Please do AC power off and on for re-connecting to EloView after recall defaults.
	OSD Lock	When selected, both Menu button and source switch button will be no response. Long press the Menu button for five (5) seconds to Lock/Unlock button.
	OSD Language	Selects which language the OSD information is displayed in. The available languages are English, French, Italian, German, Spanish, Russian, Simplified Chinese, Traditional Chinese, Japanese and Korean. Default: English.
	OSD Timeout	Adjusts how long a period of OSD button inactivity the IDS Display will wait before closing the OSD. The adjustable range is between 5 and 60 seconds. Default: 15 seconds
	Portrait Rotation	Adjusts the OSD orientation between Portrait and Landscape mode.
	Touch mode	Select normal touch mode or touch through mode. Default: Normal mode

<b>Configuration</b>	<b>Source Port Lock</b>	Deactivating the selected port, abandon video input from selected input source. Source switch OSD will also gray out locked video port. Default: Unselected
	<b>FW Update (OTA)</b>	FW upgrade. Check Elo cloud server and FW update when new FW available. Please make sure the IDSx4 has Ethernet connected. (OSD menu > Information > page2, Network Status: "Online")
	<b>FW Update (USB)</b>	FW upgrade. Use USB Type-A port to inject FW package. Need connecting to an USB thumb drive which includes FW package downloaded before starting the FW update. <b>(Recommend formatting the USB drive first in FAT32 file format.)</b>
	<b>Setting Clone via USB</b>	Import and Export device setting for massive device setting transferring. (Coming soon, the feature will be available by OTA update)
	<b>Power Button Lock</b>	When enabled, the monitor will remain ON even if the power button is pressed. If this feature is enabled and power to the monitor is lost, when power is regained, pressing the power button will turn on the monitor. Default: Disabled

## On-Screen Display (OSD) Optional Elo Part Number – E483757

Connect the OSD remote to the *OSD Remote connection* on the rear of the IDS Display. Five OSD buttons can be found on the OSD remote. There is an LED light which shows the current state of the monitor. The following are the functions that relate to the designated button.

Note: Opening the OSD menu from the remote will disable the touch functions on the OSD menu.

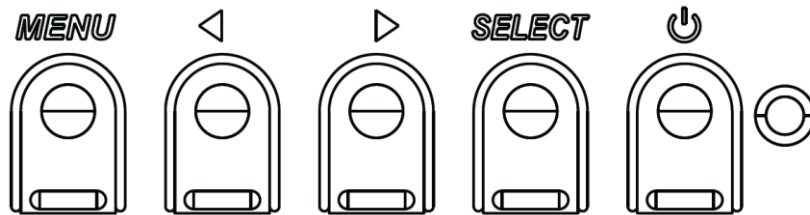

The buttons and their functionality are:

Button	Function when OSD is not displayed:	Function when OSD is displayed:
Menu	Display OSD main menu	Return to previous OSD menu
▶	n/a	Increase value of selected parameter / select next menu item
⏻	Power for the monitor	Toggles the power status of the monitor
◀	n/a	Decrease value of selected parameter / select previous menu item

## Touch Activated OSD (for ET3204L and ET5054L/ET5554L/ET6554L)

IDS ET3204L/ET5054L/ET5554L/ET6554L can open the OSD menu by touching the screen in a coded pattern. The pattern options are a series of numbers 1-9, and the location of each number is shown below. The code to open the menu is (3 → 9 → 3 → 9).

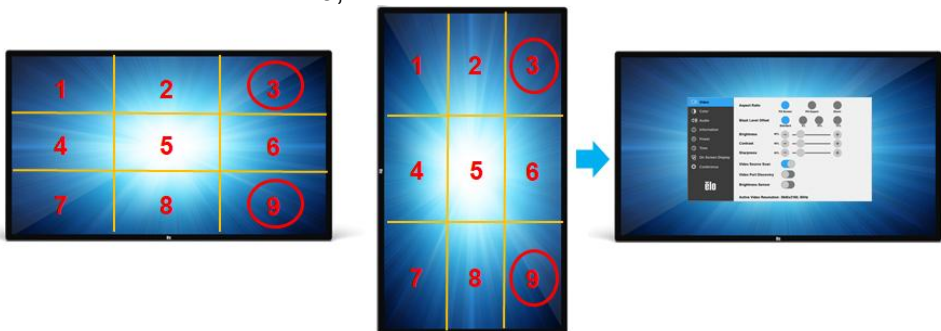

*\*Note the touch OSD menu only supports single touch, and no selection can be longer than three seconds.*

## Audio

Audio can be output from the following locations:

1. From the IDS Display speakers via the video channel
2. The Audio Out connection on the IDS Display IO area.

Note: When headphones are plugged into the audio output jack, the internal speakers turn off and audio is played over the headphones. Volume and muting of the speaker and headphone outputs are controlled by the OSD.

## CEC Functionality (Consumer Electronic Control)

The IDS Display is equipped with CEC capability. If a host device (with CEC built in) is connected to the monitor through HDMI, the monitor can be turned on by only turning the host device on.

## Controlling the IDS Display remotely

The IDS Display allows remote access from multiple host applications. Users can communicate with the monitor through either of these protocols:

	Type of Host	Connection active	HW Path
IoT (IDSx4 New)	EloView Cloud	Except Power off & Energy Saving	Wi-Fi and LAN -> IDSx4 IoT block-> Internal CMD
	Crestron Cloud Service	Except Power off & Energy Saving	Wi-Fi and LAN -> IDSx4 IoT block-> Internal CMD
MDC	RS232 via TRS3.5mm (9600 Baud)	Except Power off	External PC -> RS232 TRS3.5-> IDSx4 -> MDC
	USB (Virtual UART)	Except Power off	External PC USB -> IDSx4 USB -> MDC
	TCP/IP (Port 5000)	Except Power off & Energy Saving	Wi-Fi or Local LAN -> IDSx4 IoT -> MDC
DDC/CI	With video source input	Only when Source selected	External PC HDMI -> IDSx4 HDMI port

### IoT EloView and Crestron Cloud Service:

Refer to Section3, IDSx4 IoT connectivity for device control and monitoring

### MDC:

The host application can send a variety of different commands which will be executed on the IDS Display. For detailed information regarding the Multiple Display Control command sets, refer to the application note on Elo website.

Note. MDC example for Brightness control:

"02 6E 85 FF 04 10 00 00 06 03" – 0% Brightness

"02 6E 85 FF 04 10 00 50 56 03" – 80% Brightness

- TRS3.5mm RS232 and USB virtual UART are using 9600 Baud for command COM port settings.
- TCP/IP (Port 5000) control via Local LAN(Ethernet) or Wi-Fi\*1, sending MDC command via IP address\*2 to an IDS device.

\*1. Optional Wi-Fi: check "Section 3, IDS Display: Connecting Wi-Fi adapter"

\*2. Obtain IDS device IP: Check Information page 2 in OSD menu  
(Click "→" to access page 2)

### DDC/CI:

This is using the VESA Display Data Channel Command Interface (DDC/CI). When video source port has input from host, ex. HDMI, the host application can send a variety of different commands which will be executed on the IDS Display.

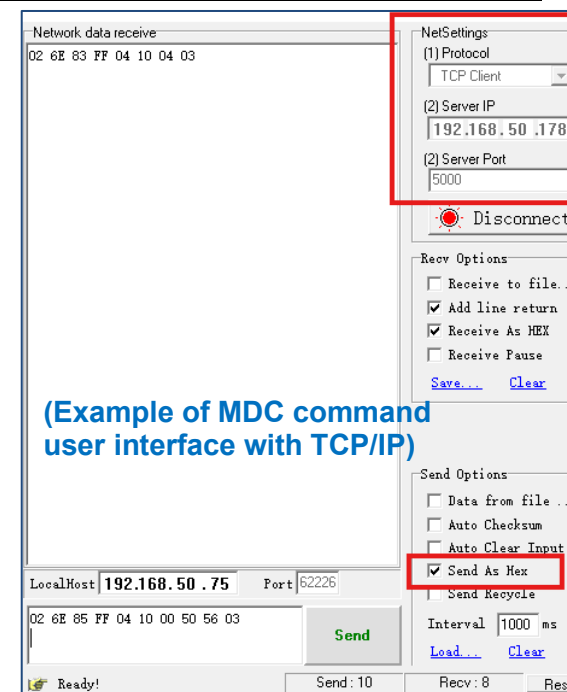

## Real Time Clock (RTC) Functionality

This IDS Display has real time clock functionality. In the OSD menu, there is a sub-menu called RTC Settings.

### **To utilize the RTC functionality:**

The user must set up the Time setting for their specific time zone. When the On/Off Schedule is *enabled*, the user can choose when to leave the monitor on and when it should be off. Individual or multiple days can be chosen.

*Example: Turn the monitor ON for Monday, Wednesday and Friday between 9:00AM and 5:00PM. All other days and time, the monitor will turn OFF.*

- *Enable the On/Off Schedule*
- *Select M W F*
- *Set the ON time for 09:00:00 and the OFF time for 17:00:00*

*\*Note that all of time settings operate on the 24-hour clock.*

## Wake-On-Touch

The touch display supports wake-on-touch functionality when the PC is in sleep mode. To enable this, please ensure that the BIOS settings have enabled USB support during the S0ix/S3/S4 sleep cycle.

## Intelligent Brightness Control and Color Sensor Functionality

This IDS Display includes a light and color sensor that can adjust the brightness of the screen and the color of the display to meet the ambient light and color levels. Details of the functionality can be found in the Section 10, Appendix A.

The light sensor can be used to wake the monitor from sleep mode. This will happen when there is a change in the amount of light from very dim (<50 lux) to bright (>200 lux). To enable this feature, ensure that the power saving mode for the monitor is disabled.

## Energy Saving Mode

IDS ET3204L/ET4304L/ET5054L/ET5554L/ET6554L can meet Energy Star 8.0 requirements, if Energy Saving Mode is enabled. When Energy Saving Mode is enabled, four side peripheral ports, MDC command and Auto Display Wake Up function will be limited. To restore full functionality of the IDS Display, disable the Energy Saving Mode



ENERGY STAR is a program run by the U.S. Environmental Protection Agency (EPA) and U.S. Department of Energy (DOE) that promotes energy efficiency. This product qualifies for ENERGY STAR in the “factory default” settings and this is the setting in which power savings will be achieved.

Changing the factory default picture settings or enabling other features will increase power consumption that could exceed the limits necessary to qualify for ENERGY STAR rating. For more information on the ENERGY STAR program, refer to [energystar.gov](http://energystar.gov).

## Stylus (Active and Passive) (Optional)

**Active Stylus** (works with PCAP models 3204L, 5054L, 5554L, and 6554L; not compatible with 4304L model)

Elo provides active stylus pens for monitors with projected capacitive touch technology.

Note: The minimum distance between two monitors should be 72cm (28.35in)  $\pm 10\%$

**Part Number:** E216215

### Features:

- Auto power-off
- Pressure detection
- Right-click
- Erase
- Pen priority (stylus input takes precedence over finger touch)

### Usage Instructions:

- **Pressure sensing:** Apply pressure to the screen to draw thicker lines; release pressure for thinner lines.
- **Right-click:** Press the button closest to the stylus tip.
- **Erase:** Press the button farthest from the stylus tip.
- **Side buttons:** Comply with Microsoft HID digitizer specifications; functionality depends on application settings.
- **Pen priority:** When both stylus and finger are detected, input follows the stylus.
- **Dual stylus use:** Requires a custom API for simultaneous operation of two stylus pens.

### Passive Stylus (IR Models Only)

Elo also offers passive stylus pens for monitors with infrared touch technology. These can be used simultaneously with finger touch.

**Part Number:** E727568

## Glove Support

IDS ET3204L/ET4304L/ET5054L/ET5554L/ET6554L can support glove thickness from 0.1mm to 1.4mm, **please switch to touch through mode when using a thick glove**. The gloves used for IDS ET3204L/ET4304L/ET5054L/ET5554L/ET6554L are as below.



Latex surgical glove (0.1mm)



Thicker glove (0.7mm – 1.4mm)

*\*Note that touch performance is highly dependent on the type of glove used. Thickness and material are the main factors. A thicker glove will result in a poorer touch performance.*

## Elo Edge Connect micro-USB peripheral ports

Available on all four sides of the monitor. The micro-USB ports are designed for Elo's optional peripherals. See [www.elotouch.com](http://www.elotouch.com) for the optional peripherals that work with the IDS ET3204L/ET4304L/ET5054L/ET5554L/ET6554L display.

The pinout is as follows:

Pin1: 5V Power

Pin2: USB D-

Pin3: USB D+

Pin4: NC

Pin5: Ground

## Conference Camera (Optional)

Elo provides an optional camera module (P/N E988153) which has a built-in noise canceling microphone. This camera is designed for video conferencing meetings and supports 1080P Full HD video output.

## Section 6: Maintenance Information

To avoid the risk of electric shock, follow all safety notices and do not disassemble the IDS Display. They are not user serviceable.

Do not block or insert anything inside any of the ventilation slots.

The IDS Display is equipped with a 3-wire, grounding power cord. The power cord plug only fits into a grounded outlet. Do not fit or modify the plug into an outlet that has not been configured for this purpose. Do not use a damaged power cord. Only use the power cord that came with your Elo IDS Display. Use of an unauthorized power cord may invalidate your warranty.

Ensure that the system is maintained and runs within the specified environmental conditions listed in the products specifications available on the Elo Touch Solutions website [www.elotouch.com](http://www.elotouch.com).

**CAUTION: Double Pole, neutral fusing. Disconnect mains before servicing.**

# Section 7: Technical Support

## Technical Assistance

### Technical Specifications

visit [www.elotouch.com/products](http://www.elotouch.com/products)  
for technical specifications for this device

### Support

Visit [www.elotouch.com/support](http://www.elotouch.com/support) for technical support

Refer to last page for worldwide technical support phone numbers.

# Section 8: Regulatory Information

## Waste Electrical & Electronic Equipment Directive (WEEE)



This product should not be disposed of with household waste. It should be deposited at a facility that enables recovery and recycling.

Elo has put in place recycling arrangements in certain parts of the world. For information on how you can access these arrangements, please visit [www.elotouch.com/e-waste-recycling-program](http://www.elotouch.com/e-waste-recycling-program).

## Electrical Safety Information

Compliance is required with respect to the voltage, frequency, and current requirements indicated on the manufacturer's label. Connection to a different power source than those specified herein will result in improper operation, damage to the equipment, or pose a fire hazard if the limitations are not followed.

There are no operator serviceable parts inside this equipment. There are hazardous voltages generated by this equipment which constitute a safety hazard. Service should be provided only by a qualified service technician. Contact a qualified electrician or the manufacturer if there are questions about the installation prior to connecting the equipment to mains power. CAUTION: Double Pole, neutral fusing. Disconnect mains before servicing.

## Emissions and Immunity Information

Notice to Users in the United States. This equipment has been tested and found to comply with the limits for a Class A digital device, pursuant to Part 15 of the FCC Rules. These limits are designed to provide reasonable protection against harmful interference when the equipment is operated in a commercial environment. This equipment generates, uses, and can radiate radio frequency energy and, if not installed and used in accordance with the instruction manual, may cause harmful interference to radio communications. Operation of this equipment in a residential area is likely to cause harmful interference in which case the user will be required to correct the interference at his own expense. This device complies with Part 15C of the FCC Rules. Operation is subject to the following two conditions:

- 1) This device may not cause harmful interference; and
- 2) This device must accept any interference, including interference that may cause undesired operation of the device.

Notice to Users in Canada:

This equipment complies with the Class A limits for radio noise emissions from digital apparatus as established by the Radio Interference Regulations of Industrial Canada.

CAN ICES3(A)/NMB3(A)

This device complies with Industry Canada's license-exempt RSSs. Operation is subject to the following two conditions:

- (1) This device may not cause interference; and
- (2) This device must accept any interference, including interference that may cause undesired operation of the device.

Le présent appareil est conforme aux CNR d'Industrie Canada applicables aux appareils radio exempts de licence.

L'exploitation est autorisée aux deux conditions suivantes :

- (1) l'appareil ne doit pas produire de brouillage ; et
- (2) l'utilisateur de l'appareil doit accepter tout brouillage radioélectrique subi, même si le brouillage est susceptible d'en compromettre le fonctionnement.

Notice to Users in the European Union: Use only the provided power cords and interconnecting cabling provided with the equipment. Substitution of provided cords and cabling may compromise electrical safety or CE Mark Certification for emissions or immunity as required by the following standards:

This Information Technology Equipment (ITE) is required to have a CE Mark on the Manufacturer's label which means that the equipment has been tested to the following Directives and Standards: This equipment has been tested to the requirements for the CE Mark as required by EMC Directive 2014/30/ EU as indicated in European Standard EN 55032 Class A and the Low Voltage Directive 2014/35/EU as indicated in European Standard EN 60950-1.

General Information to all Users: This equipment generates, uses and can radiate radio frequency energy. If not installed and used according to this manual, the equipment may cause interference with radio and television communications. There is, however, no guarantee that interference will not occur in any particular installation due to site-specific factors.

1. In order to meet emission and immunity requirements, the user must observe the following:
  - a. Use only the provided I/O cables to connect this digital device with any computer.
  - b. To ensure compliance, use only the provided manufacturer's approved line cord.
  - c. The user is cautioned that changes or modifications to the equipment not expressly approved by the party responsible for compliance could void the user's authority to operate the equipment.
2. If this equipment appears to cause interference with radio or television reception, or any other device:
  - a. Verify as an emission source by turning the equipment off and on. If you determine that the equipment is causing the interference, try to correct the interference by using one or more of the following measures:

- i. Move the digital device away from the affected receiver.
- ii. Reposition (turn) the digital device with respect to the affected receiver.
- iii. Reorient the affected receiver's antenna.
- iv. Plug the digital device into a different AC outlet so the digital device and the receiver are on different branch circuits.
- v. Disconnect and remove any I/O cables that the digital device does not use. (Unterminated I/O cables are a potential source of high RF emission levels.)
- vi. Plug the digital device into only a grounded outlet receptacle. Do not use AC adapter plugs. (Removing or cutting the line cord ground may increase RF emission levels and may also present a lethal shock hazard to the user.)

If you need additional help, consult your dealer, manufacturer, or an experienced radio or television technician.

## Agency Certifications

The following certifications and marks have been issued or declared for the IDS ET3204L/ET4304L/ET5054L/ET5554L/ET6554L monitor:

- UL, FCC (US) - Class A
- cUL, IC (Canada)
- CB (International safety)
- CE (Europe) - Class A
- RCM (Australia)
- VCCI (Japan)
- CCC (China) (for TouchPro version only)

## China RoHS

In accordance with Chinese law (Management Methods for the Restriction of the Use of Hazardous Substances in Electrical and Electronic Products), the section below lists out the name and amount of the toxic and/or hazardous materials that this product may contain.



### Hazardous Substances

Component Name	Lead (Pb)	Mercury (Hg)	Cadmium (Cd)	Hexavalent Chromium (Cr6+)	Polybrominated Biphenyls (PBB)	Polybrominated Diphenyl Ethers (PBDE)
Plastic Parts	○	○	○	○	○	○
Wire and Cable Assembly	○	○	○	○	○	○
PCBA	X	○	○	○	○	○

This table is prepared in accordance with the provisions of SJ/T 11364

O: Indicates that said hazardous substance contained in all homogenous materials for this part is below the limit requirement of GB/T 26572.

X: Indicates that said hazardous substance contained in at least one of the homogenous materials used for this part is above the limit requirement of GB/T 26572.

For items marked with X, exemptions were taken according to EU RoHS.

## Explanation of Markings

In accordance with the SJ/T11364 requirement, electrical and electronic products are marked with the following pollution control logo.

The Environment-Friendly Use Period for this product is 10 years. The product will not leak or mutate under normal operating conditions listed below, so that the use of this electronic information product will not result in any severe environmental pollution, any bodily injury, or damage to any assets.



Operating and Storage Temperature: See table on next page.

It is encouraged and recommended that product packaging be recycled and reused according to local laws.



# Power Specifications

## Electrical Ratings

---

Input	100 - 240 VAC 50/60Hz
-------	-----------------------

---

# Operating & Storage Conditions

## Operating Conditions

---

Temperature	Portrait/Landscape/Tilt ( $\leq 15^\circ$ ) 0°C - 40°C / 32°F to 104°F
-------------	--

	Tabletop 0°C - 35°C / 32° F to 95° F
--	--------------------------------------

Humidity	20% to 80% (non-condensing)
----------	-----------------------------

---

## Storage Conditions

---

Temperature	-20°C - 60°C / -4° F to 140° F
-------------	--------------------------------

Humidity	10% to 95% (38.7° C max wet bulb temperature)
----------	---

## Section 9: Warranty Information

For warranty information, go to <http://support.elotouch.com/warranty/>

# Section 10: Appendix A

Light Sensor Curve

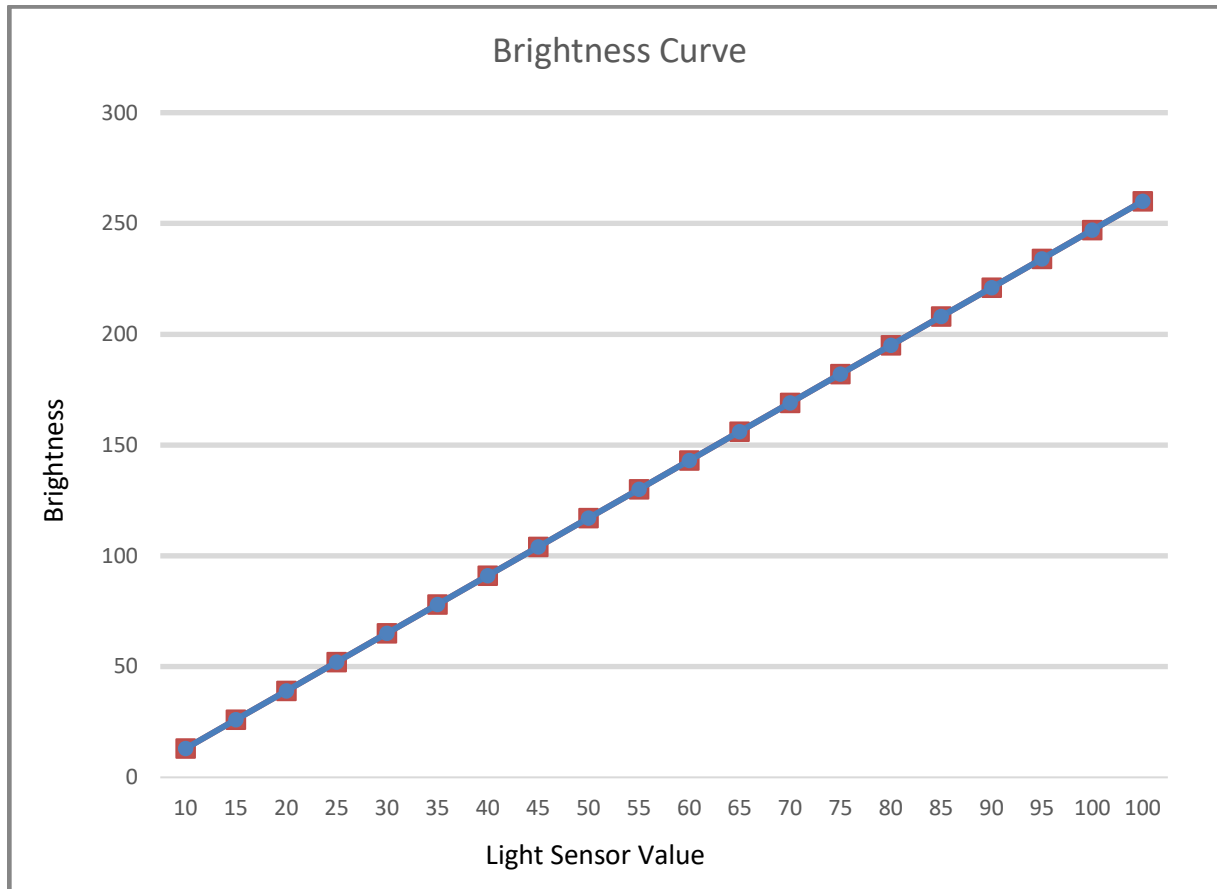

## Color Sensor

The color sensor functions according to the following chart:

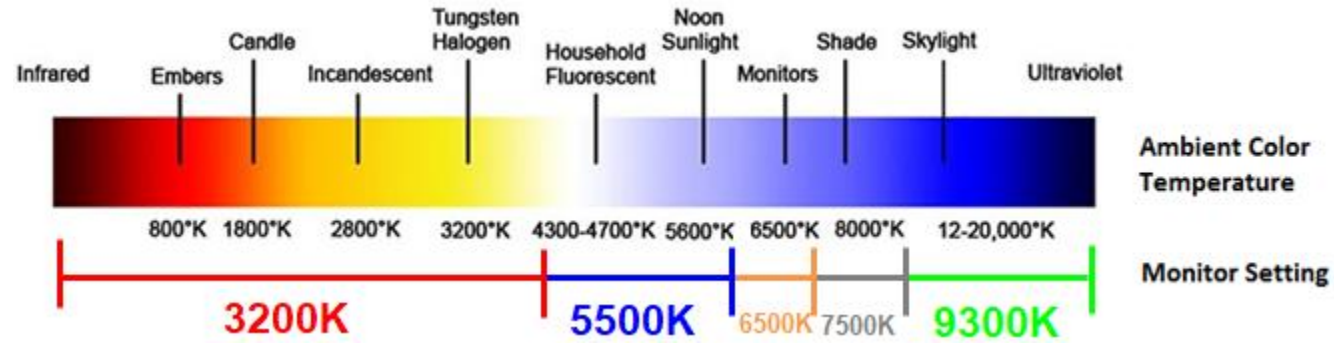

# www.elotouch.com

Visit our website for the latest:

- Product Information
- Specifications
- Upcoming Events
- Press Releases
- Software Drivers

To find out more about our extensive range of Elo touch solutions, go to [www.elotouch.com](http://www.elotouch.com), or call the office nearest you.

---

#### North America

Tel +1 408 597 8000

[elosales.na@elotouch.com](mailto:elosales.na@elotouch.com)

#### Europe

Tel +32 16 930 136

[emea.salse@elotouch.com](mailto:emea.salse@elotouch.com)

#### Asia-Pacific

Tel +86 (21) 3329 1385

[www.elotouch.com.cn](http://www.elotouch.com.cn)

